

No.	Date	By	Revision

GRINDSTONE SIDEWALK PROJECT
 (HYDE PARK AVE. TO NORFLEET DR.)
 Preliminary Plan Sheet

Mission
 Provide safe, sustainable
 infrastructure that promotes
 positive communities.

701 East Broadway
 P.O. Box 6015
 Columbia, MO 65205
 (573) 875-2489

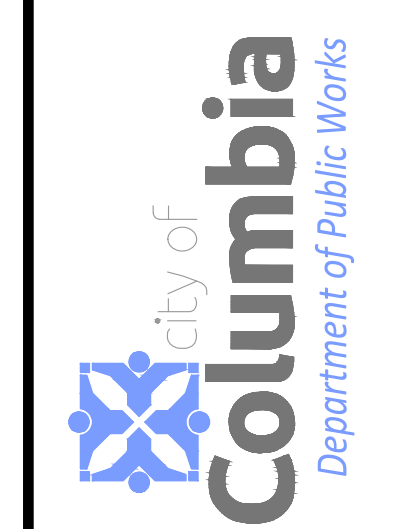

Shane Steven Creach
 Registered Professional
 Engineer
 PE-2007011061

File No. 00820
 Scale: 1"=20'
 Date: 4/24/2023
 Des. E.M.F
 Dwn. A.A.E
 Chk. A.A.A

c:\cadd\proj\sidewalk\grindstone\long_sidewalk_sap\design\grindstone_sidewalk_sap.dwg

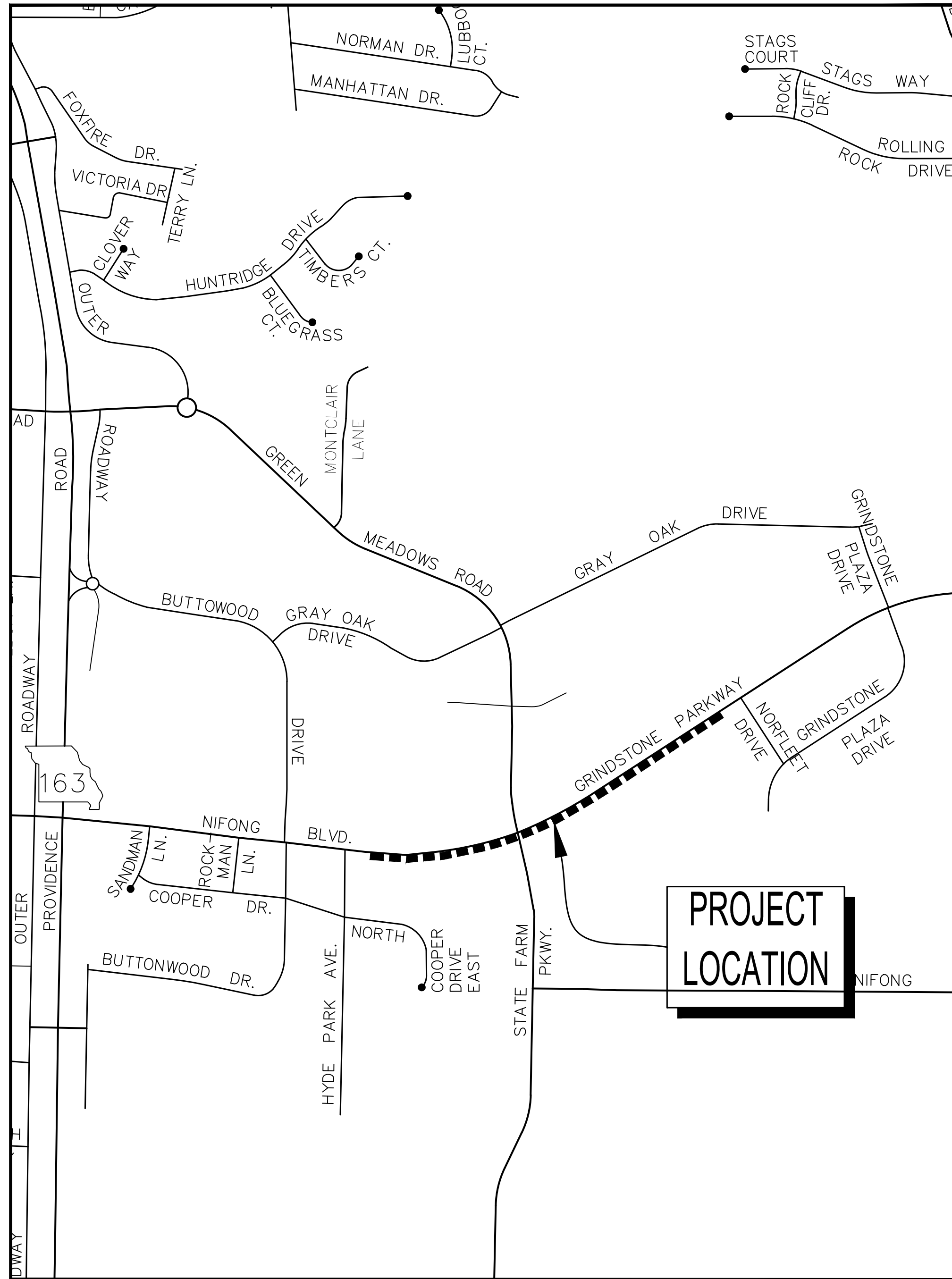

LOCATION MAP
SCALE: 1"=500'

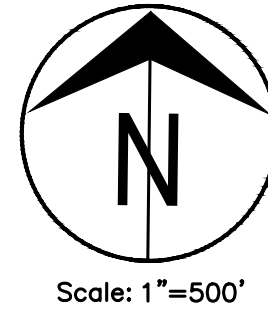

Scale: 1"=500'

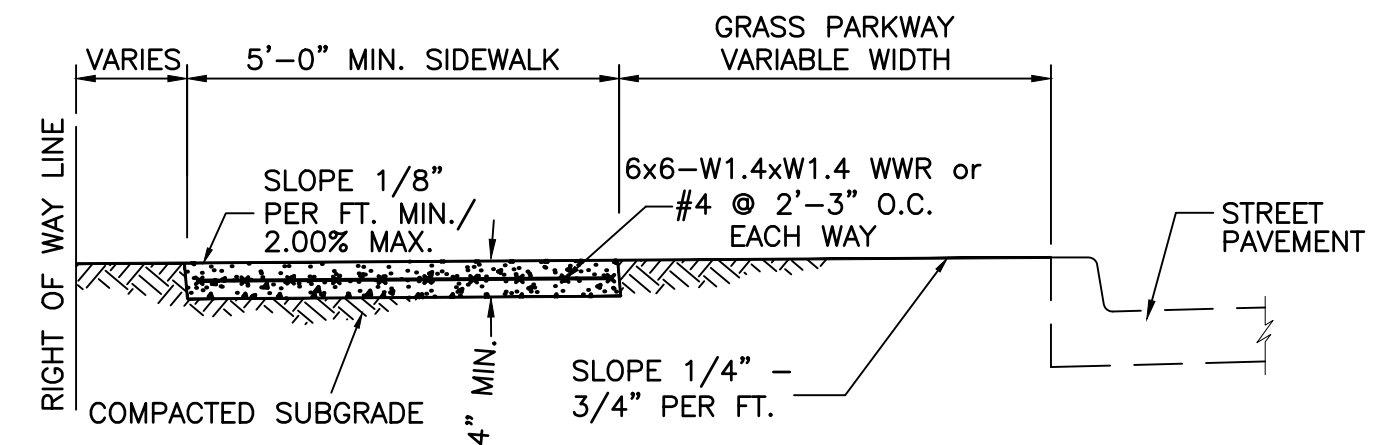

SIDEWALK WITH GRASS PARKWAY
(NOT TO SCALE)

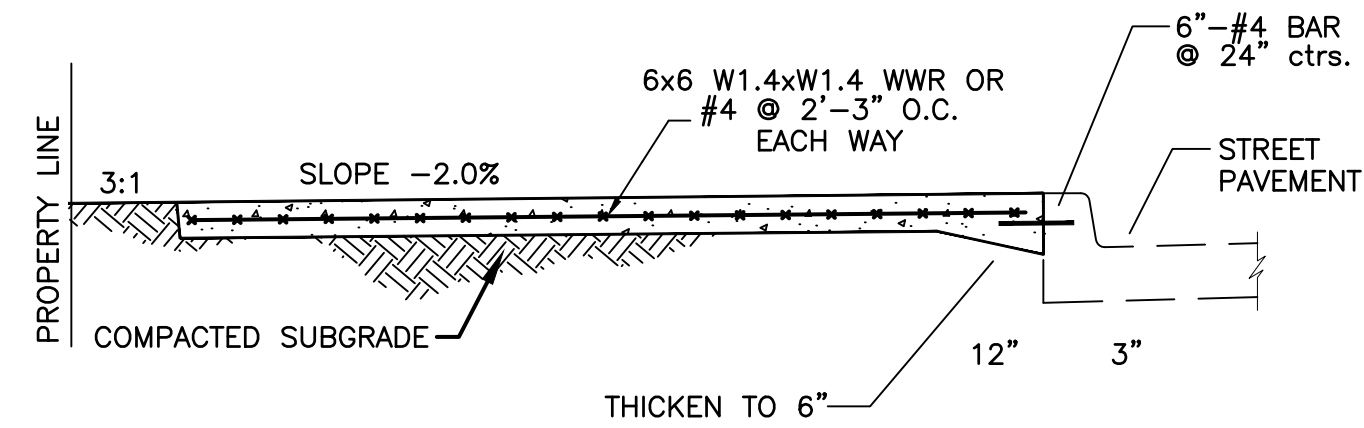

SIDEWALK AT BACK OF CURB
(NOT TO SCALE)

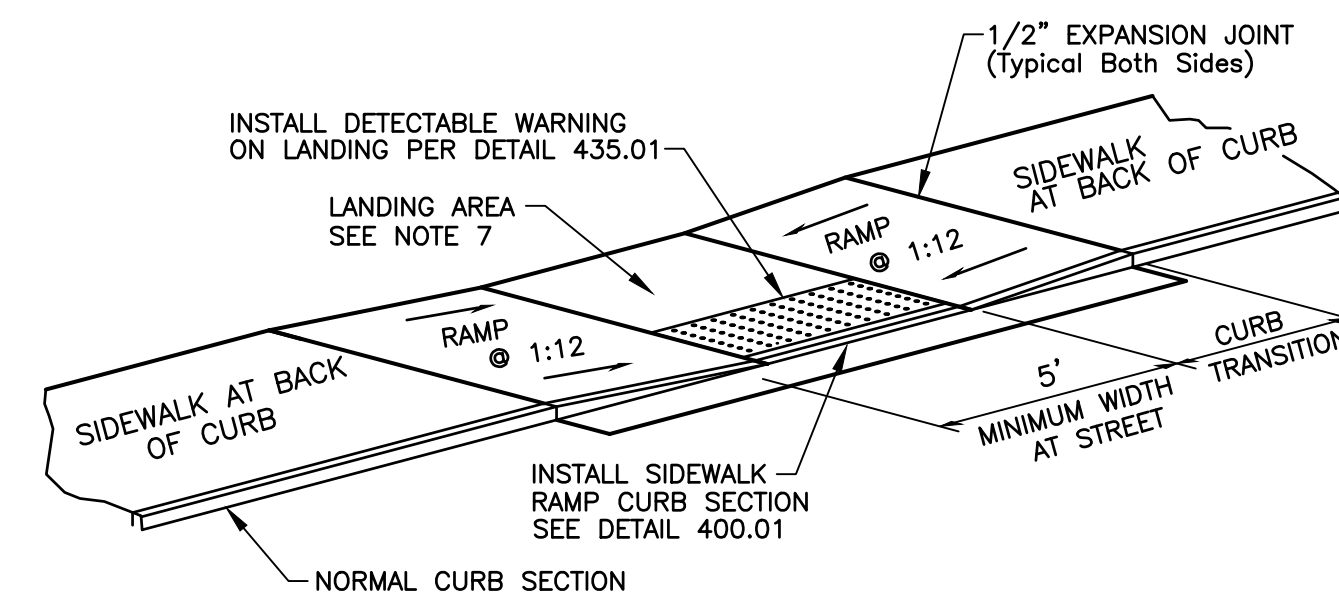

SIDEWALK RAMP AND LANDING
(NOT TO SCALE)

No.	Date	By	Revision

GRINDSTONE SIDEWALK PROJECT
(HYDE PARK AVE. TO NORFLEET DR.)

Preliminary Plan Sheet

Mission
Provide safe, sustainable infrastructure that promotes positive communities.

701 East Broadway
P.O. Box 6015
Columbia, MO 65205
(573) 875-2489

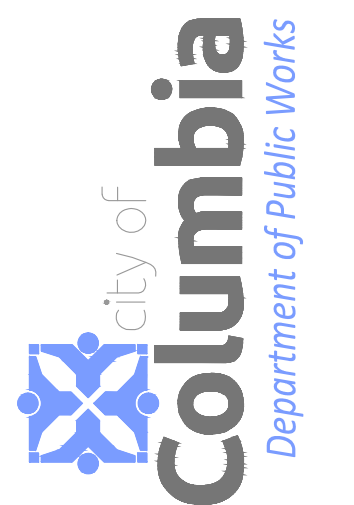

Shane Steven Creech Registered Professional Engineer PE-2007011061
File No. 00820
Scale: None
Date: 4/24/2023
Des. E.M.F
Dwn. A.A.E
Chk. A.A.A

c:\caddpro\sidewalk\grindstone-nifong\sidewalk_gsp\design\grindstone sidewalk - sw with grass.dwg