

PRELIMINARY PLAT

# THE VINEYARDS, PLAT NO. 2

LOCATED IN EAST 1/2 OF SECTION 21 AND IN THE WEST 1/2 OF SECTION 22, TOWNSHIP 48 NORTH, RANGE 12 WEST COLUMBIA, BOONE COUNTY, MISSOURI  
AUGUST 31, 2015

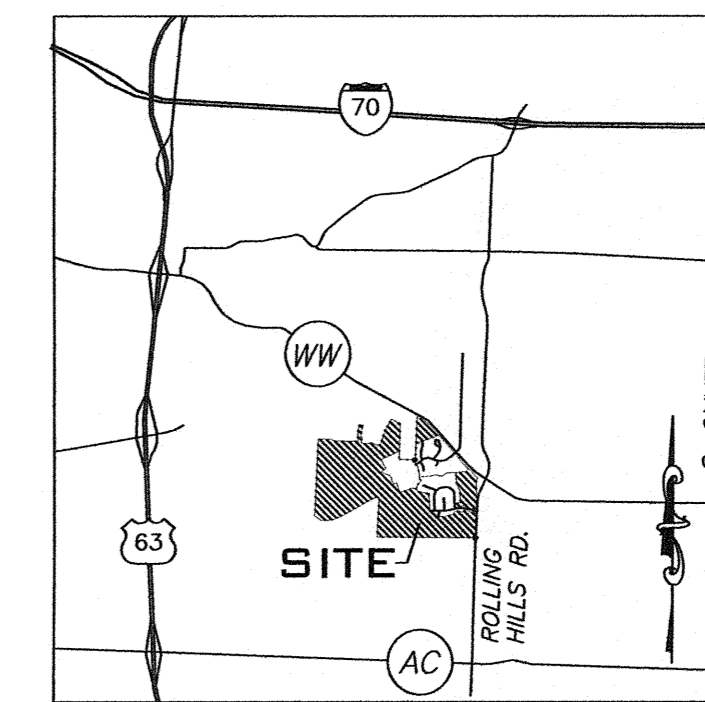

LOCATION MAP  
NOT TO SCALE

### SITE DATA

ZONING: R-1/PUD  
ACREAGE:  
LOCATION: LOCATED IN SECTION 21 & 22, T48N, R12W, CITY OF COLUMBIA, BOONE COUNTY, MISSOURI  
**OWNER:**  
VINEYARDS COLUMBIA, LLC  
1213 BRADSHAW AVE  
COLUMBIA, MO 65203

### BENCHMARK DATA

DNR GRS ALUMINUM DISK STAMPED 80-86, LOCATED ON THE NORTH SIDE OF ROUTE WW, APPROXIMATELY 45 FEET WEST OF THE DRIVEWAY TO THE OLD HAWTHORNE GOLF COURSE CLUBHOUSE.  
ELEV= 818.34

### LEGAL DESCRIPTION

TWO TRACTS OF LAND LOCATED IN THE EAST HALF OF SECTION 21 AND IN THE WEST HALF OF SECTION 22, TOWNSHIP 48 NORTH, RANGE 12 WEST BEING PART OF THE SURVEY RECORDED IN BOOK 2871, PAGE 132 AND BEING PART OF THE SURVEY RECORDED IN BOOK 2605, PAGE 21 IN THE CITY OF COLUMBIA, BOONE COUNTY, MISSOURI.

### STREAM BUFFER STATEMENT

THIS TRACT IS EXEMPTED FROM THE CITY OF COLUMBIA STREAM BUFFER ORDINANCE AS DETERMINED BY THE USGS MAP FOR COLUMBIA QUADRANGLE, BOONE COUNTY, MISSOURI AND ARTICLE X OF CHAPTER 12A SECTION 232(2) OF THE CITY OF COLUMBIA CODE OF ORDINANCES.

### FLOOD PLAIN STATEMENT

THIS TRACT IS LOCATED WITHIN THE 100-YEAR FLOOD PLAIN AS SHOWN BY FLOOD INSURANCE RATE MAP #28019C02950 DATED MARCH 17, 2011.

### STORM WATER

A COLUMBIA PUBLIC ELEMENTARY SCHOOL IS PLANNED FOR LOT 401. THE CONSTRUCTION ON THIS LOT WILL PROVIDE STORM WATER DETENTION AND WATER QUALITY TREATMENT AS REQUIRED IN ARTICLE V, OF CHAPTER 12A OF THE COLUMBIA CODE AS OF THE DATE OF APPROVAL OF THIS PLAT. THE REMAINDER OF THIS DEVELOPMENT WILL PROVIDE STORM WATER MANAGEMENT AS SHOWN ON THE PRELIMINARY PLAT APPROVED NOVEMBER 10, 2005. DEVELOPMENT BY THESE STANDARDS WILL RESULT IN DECREASED WATERSHED IMPACT BY REDUCING THE NUMBER OF RESIDENTIAL LOTS FROM THE PREVIOUSLY APPROVED PRELIMINARY PLAT.

### PHASING NOTES

THIS DEVELOPMENT SHALL BE ALLOWED TO BE CONSTRUCTED IN MULTIPLE PHASES. THE PHASES OF CONSTRUCTION MAY BE BUILT OVER AN UNSPECIFIED NUMBER OF YEARS.

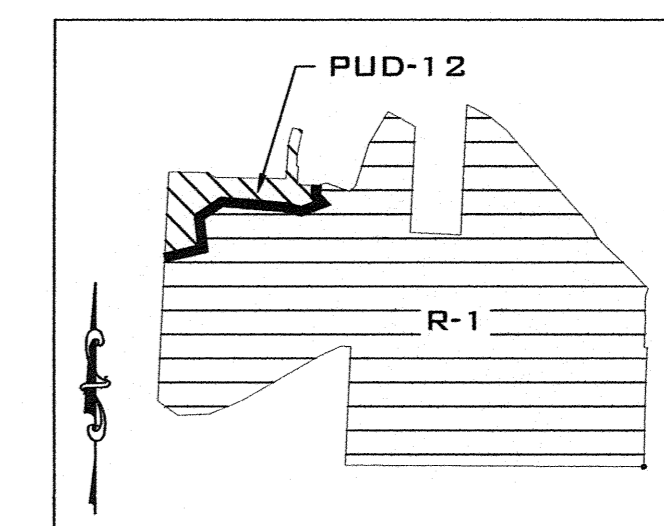

EXISTING ZONING DETAIL

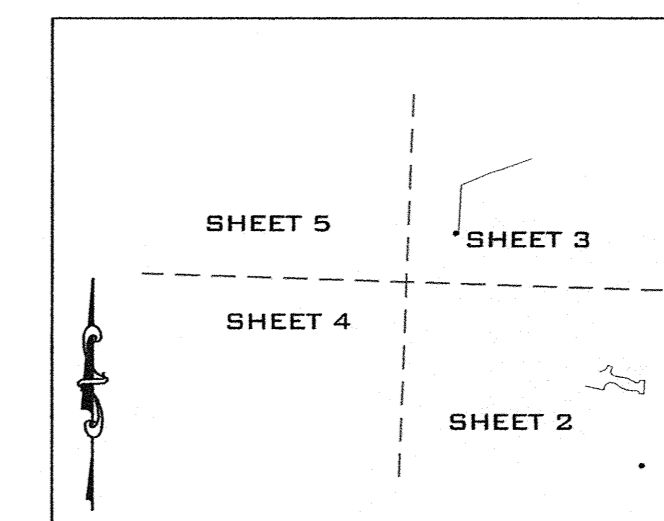

PLAN SHEET DETAIL

THIS DOCUMENT HAS BEEN ELECTRONICALLY SIGNED, SEALED AND DATED.



CHRISTOPHER M. SANDER  
MO E-2001004658  
SEPTEMBER 28, 2015

SURVEY AND PLAT BY  
A CIVIL GROUP  
CORPORATE NO. 2001006116

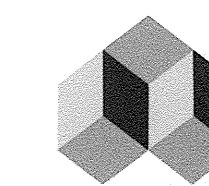

### A CIVIL GROUP

CIVIL ENGINEERING - PLANNING - SURVEYING  
3401 BROADWAY BUSINESS PARK COURT  
SUITE 1015  
COLUMBIA, MO 65203  
PH: (573) 817-5750, FAX: (573) 817-1677  
MISSOURI CERTIFICATE OF AUTHORITY: 2001006115

SCALE: 1" = 200'

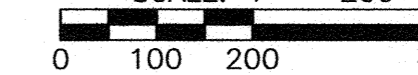

BEARINGS ARE REFERENCED TO GRID NORTH OF THE MISSOURI STATE PLANE COORDINATE SYSTEM (CENTRAL ZONE), OBTAINED FROM GPS OBSERVATION.



APPROVED BY THE CITY OF COLUMBIA PLANNING AND ZONING COMMISSION THIS 19<sup>th</sup> DAY OF November 2015.  
STEPHEN REICHLIN, VICE-CHAIRMAN

# THE VINEYARDS, PLAT NO. 2

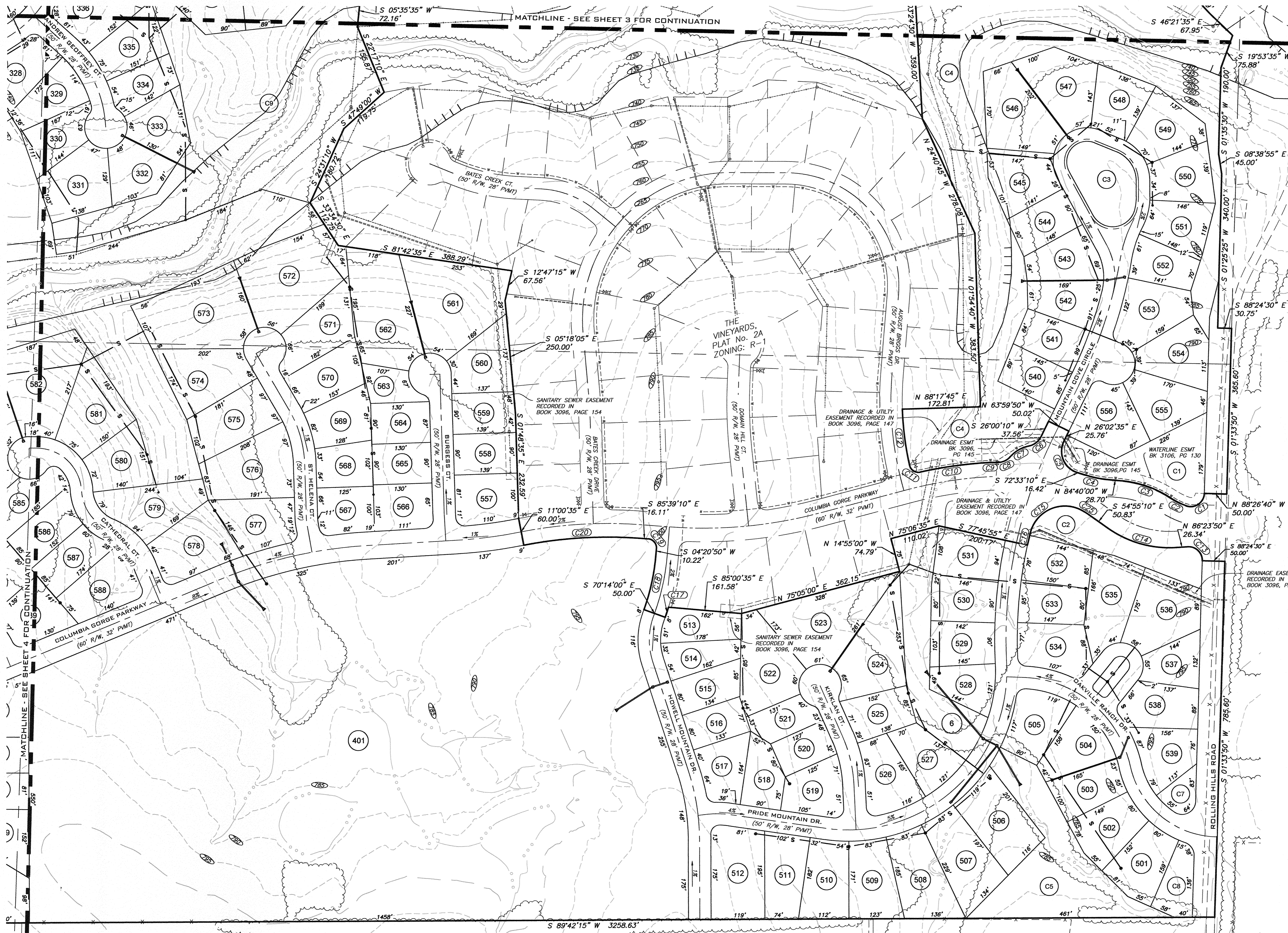

CURVE TABLE				
#	Δ	RADIUS	LENGTH	CHORD
C1	106°38'21"	30.00	55.84	S 55°08'35" W, 48.12'
C2	13°55'43"	164.00	39.87	N 63°41'45" W, 39.77'
C3	27°55'59"	236.00	115.06	N 70°41'55" W, 113.92'
C4	12°06'48"	264.00	55.81	N 78°36'35" W, 55.71'
C5	98°33'05"	49.00	84.28	N 23°16'30" W, 74.27'
C6	52°39'59"	39.00	35.85	S 52°20'00" W, 34.60'
C7	37°29'22"	74.00	48.42	S 59°55'05" W, 47.56'
C8	48°31'55"	36.00	30.49	S 65°26'20" W, 29.59'
C9	3°50'34"	530.00	35.55	S 87°47'00" W, 35.54'
C10	8°29'13"	930.00	137.76	S 81°37'05" W, 137.63'
C11	90°11'07"	20.00	31.48	N 57°32'05" W, 28.33'
C12	10°42'09"	670.00	125.15	N 07°22'00" W, 124.97'
C13	95°12'27"	30.00	49.85	S 46°00'20" E, 44.31'
C14	38°41'03"	236.00	159.34	S 74°15'40" E, 156.33'
C15	104°32'55"	78.50	143.25	N 66°31'05" E, 124.19'
C16	1°37'29"	975.00	27.65	N 13°04'00" E, 27.65'
C17	2°34'05"	524.94	23.53	N 18°28'55" E, 23.53'
C18	15°25'07"	474.99	127.82	S 12°03'25" W, 127.44'
C19	89°58'58"	20.00	31.41	S 40°39'10" E, 28.28'
C20	15°21'29"	970.00	280.01	N 86°40'10" E, 259.23'
C25	6°45'00"	164.02	19.32	S 58°17'40" E, 19.31'

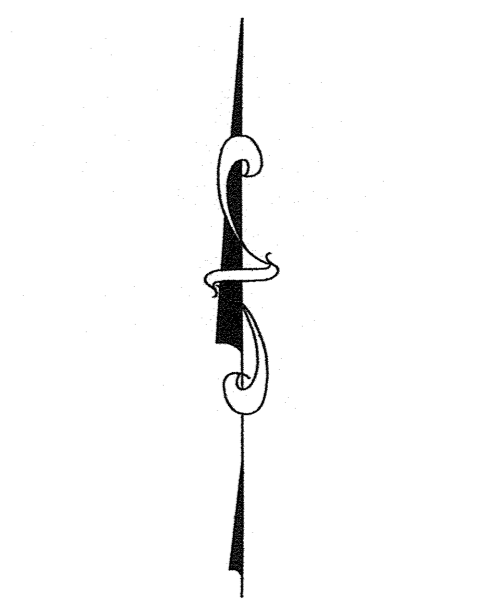

THIS DOCUMENT HAS BEEN ELECTRONICALLY SIGNED, SEALED AND DATED.



CHRISTOPHER M. SANDER  
 MO E-2001004658  
 SEPTEMBER 28, 2015  
 SURVEY AND PLAT BY  
 A CIVIL GROUP  
 CORPORATE NO. 2001006116

**A CIVIL GROUP**  
 CIVIL ENGINEERING - PLANNING - SURVEYING  
 3401 BROADWAY BUSINESS PARK COURT  
 SUITE 105  
 COLUMBIA, MO 65203  
 PH: (573) 817-5750, FAX: (573) 817-1677  
 MISSOURI CERTIFICATE OF AUTHORITY: 2001006115

# THE VINEYARDS, PLAT NO. 2

### LEGEND

- MH ○ EXISTING SANITARY MANHOLE
- MH ● PROPOSED SANITARY MANHOLE
- CO ○ EXISTING SANITARY CLEANOUT
- CO ● PROPOSED SANITARY CLEANOUT
- FH ▽ EXISTING FIRE HYDRANT
- FH ▴ PROPOSED FIRE HYDRANT
- ET □ EXISTING ELECTRIC TRANSFORMER
- ET ○ EXISTING TELEPHONE BOX
- PP ○ EXISTING UTILITY POLE
- WV × EXISTING WATER VALVE
- 2% ▬ PROPOSED STREET GRADE
- HP ▲ PROPOSED HIGH POINT (CONCEPT. ONLY)
- X — EXISTING FENCE
- UE — EXISTING UNDERGROUND ELECTRIC
- OE — EXISTING OVER-HEAD ELECTRIC
- G — EXISTING GAS
- S — EXISTING SANITARY
- S — PROPOSED SANITARY
- W — EXISTING WATER
- W — PROPOSED WATER
- □ — EXISTING STORM SEWER
- □ — PROPOSED STORM SEWER
- CATV — EXISTING CABLE TELEVISION
- (E) — EXISTING FLOWLINE (E)
- — EXISTING TREENLINE
- — APPROXIMATE PRESERVED TREENLINE
- — EXISTING CONTOUR
- — CITY OF COLUMBIA CORPORATE LIMITS

### GENERAL NOTES:

- STREET R/W SHALL BE 50 FOOT WIDE RESIDENTIAL STREET, UNLESS OTHERWISE NOTED.
- DEVELOPER WILL COORDINATE WITH PWSO #9 FOR THE DESIGN OF WATER LINES TO SERVE THIS DEVELOPMENT.
- DEVELOPER WILL COORDINATE WITH BOONE ELECTRIC COOPERATIVE FOR THE DESIGN OF ELECTRIC LINES TO SERVE THIS DEVELOPMENT.
- DEVELOPER WILL COORDINATE WITH AMEREN UE FOR THE DESIGN OF GAS LINES TO SERVE THIS DEVELOPMENT.
- ALL PUBLIC SANITARY SEWER EXTENSIONS SHALL BE MINIMUM OF 8" DIAMETER. SEWERS NOT CONSTRUCTED ALONG FRONTS OF LOTS TO BE LOCATED WITHIN 16 FOOT WIDE EASEMENTS OR EASEMENTS EQUAL TO THE DEPTH OF THE SEWER IF SEWER IS GREATER THAN 16 FEET. NO SEWER TAPS WILL BE GREATER THAN 20 FEET.
- LOT NUMBER SHOWN ARE FOR INVENTORY PURPOSES ONLY.
- THE CUL-DE-SACS ARE PROPOSED TO HAVE A MINIMUM PAVEMENT RADIUS OF 38 FEET.
- NO DIRECT ACCESS SHALL BE ALLOWED DIRECTLY ONTO STATE ROUTE WW OR ROLLING HILLS ROAD FROM SINGLE FAMILY LOTS.
- ALL DIMENSIONS ARE FROM BACK OF CURB UNLESS SHOWN OTHERWISE.
- A 5' SIDEWALK SHALL BE CONSTRUCTED ALONG ALL INTERNAL STREETS.
- LOTS 731 AND 732 ARE TO BE RESERVED BY THE DEVELOPER FOR FUTURE DEVELOPMENT. THE STUB TO THE PROPERTY TO THE WEST MAY OR MAY NOT BE THE FINAL ALIGNMENT. THIS WILL BE DETERMINED AT THE TIME OF THE FINAL PLAT AND WILL BE DECIDED DUE TO THE PROPOSED USE OF THESE LOTS AND THE PROPERTY TO THE WEST.
- LOT 730 MAY BE CONVEYED TO COLUMBIA PARKS AND RECREATION FOR DEVELOPMENT OF A PARK AS DESCRIBED IN THE DEVELOPMENT AGREEMENT RECORDED IN BOOK 2800 AT PAGE 33. THE DEVELOPER RESERVES THE RIGHT TO DEVELOP THIS LOT IF IT IS NOT ACQUIRED BY THE CITY OF COLUMBIA WITH APPROVAL OF A REVISED PRELIMINARY PLAT (PUD PLAN). THE STREET CONNECTION TO EL DORADO WILL BE PLANNED AS PART OF A PUD DEVELOPMENT PLAN OF LOT 729.
- LOTS 728 AND 729 SHALL BE RESERVED BY THE DEVELOPER FOR FUTURE DEVELOPMENT. FUTURE DEVELOPMENT MAY INCLUDE RESIDENTIAL UNITS, PARKLAND, GREENSPACE PRESERVATION, ETC. GREEN/OPEN SPACE WITHIN THE LOTS MAY BE SUBDIVIDED FOR FUTURE ASSIGNMENT TO VARIOUS ENTITIES (HOME OWNER'S ASSOCIATION, PARKS AND RECREATION, ETC.)
- A GREENSPACE TRAIL EASEMENT IS TO BE DEDICATED TO THE CITY ALONG THE SOUTH FORK OF THE GRINDSTONE. PER APPROVED DEVELOPMENT AGREEMENT THIS EASEMENT IS TO BE A MINIMUM 10 FEET IN WIDTH. IT IS THE INTENT OF THE DEVELOPER TO GRANT AN EASEMENT WITH A MINIMUM WIDTH OF 50 FEET.
- THE TRAIL EASEMENTS SHOWN ARE FOR PEDESTRIAN CONNECTIVITY TO THE FUTURE TRAIL ALONG THE SOUTH FORK OF THE GRINDSTONE AS WELL AS FOR INNER SUBDIVISION CONNECTIVITY. GENERALLY, THE PEDESTRIAN ACCESS LOCATIONS SHALL BE PLACED AT AN AVERAGE DISTANCE NOT EXCEEDING 1000 FEET. THE INTENT OF GRANTING THESE EASEMENTS IS FOR THE FUTURE CONSTRUCTION OF A TRAIL WITHIN SAID EASEMENT. IT IS NOT TO BE ASSUMED THAT THE TRAILS ARE TO BE CONSTRUCTED PRIOR TO ANY BUILDING PERMIT OR CERTIFICATE OF OCCUPANCY FOR ANY LOT WITHIN THE SUBDIVISION.
- IT IS THE INTENT TO CONVEY LOT 401 TO COLUMBIA PUBLIC SCHOOLS FOR FUTURE CONSTRUCTION OF A SCHOOL AND THE AMENITIES OF THE SCHOOL.
- THIS PROPERTY IS SUBJECT TO THE DEVELOPMENT AGREEMENT RECORDED IN BOOK 2800, PAGE 33.
- ALL R-1 LOTS SHALL HAVE A MINIMUM 25' FRONT BUILDING SETBACK UNLESS OTHERWISE NOTED. PLANNED DISTRICT LOTS SHALL HAVE BUILDING SETBACKS IN COMPLIANCE WITH ITS ZONING.
- A MINIMUM 10' UTILITY EASEMENT SHALL BE PROVIDED ADJACENT TO ALL PROPOSED STREETS SHOWN UNLESS LABELED OTHERWISE. UTILITY EASEMENT WIDTHS WILL BE SUBJECT TO REVIEW AND APPROVAL OF ALL APPLICABLE UTILITY SERVICE PROVIDERS. AN EXISTING 20" UTILITY EASEMENT IS LOCATED ADJACENT TO BOTH SIDES OF COLUMBIA GORGE PKWY FROM ROLLING HILLS ROAD TO THE WEST AND AROUND BOTH SIDES OF THE FIRST INTERSECTION.
- COMMON AREA LOTS DESIGNATED WITH A "C" ARE NOT FOR RESIDENTIAL DEVELOPMENT AND WILL BE TRANSFERRED TO A HOME OWNERS ASSOCIATION FOR MAINTENANCE. NUMBER, SIZE, CONFIGURATION, AND LOCATION OF COMMON LOTS SUBJECT TO FINAL DESIGN. COMMON LOTS MAY BE USED FOR LANDSCAPING, GREENSPACE, STORMWATER BMP'S, SIGNS AS ALLOWED BY ZONING REGULATIONS, AND OTHER NEIGHBORHOOD AMENITIES. NECESSARY EASEMENTS SHALL BE DEDICATED AT TIME OF FINAL PLATTING. THE DEVELOPER RESERVES THE RIGHT TO DEVELOP THESE LOTS FOR RESIDENTIAL USES WITH APPROVAL OF A REVISED PRELIMINARY PLAT.
- DRAINAGE EASEMENTS SHALL HAVE A MINIMUM WIDTH OF 16' OR WIDER AS NEEDED AND SHALL BE PROVIDED TO CONTAIN THE RUNOFF IN CONCENTRATED FLOWS FROM A 100-YEAR RAINFALL EVENT.
- STREET ALIGNMENTS MAY BE ALTERED WITH FINAL DESIGN AS NEEDED TO MAXIMIZE SIGHT DISTANCE, AND MINIMIZE GRADING DISTURBANCE AT ENGINEERS DISCRETION.
- STREET GRADES, STORM SEWER PIPE AND STORM INLETS, AND SANITARY SEWER LOCATIONS SHOWN ARE CONCEPTUAL IN NATURE AND WILL BE REFINED WITH THE FINAL DESIGN.

### UTILITIES

#### NATURAL GAS

AMEREN UE  
2001 MAGUIRE BLVD  
COLUMBIA, MISSOURI 65201  
CONTACT: CHAD WARREN  
(573) 876-3063

#### SANITARY SEWER

CITY OF COLUMBIA  
P.O. BOX 6015  
PUBLIC WORKS DEPARTMENT  
COLUMBIA, MISSOURI 65205  
CONTACT: LINDSEY SCHAEFER  
(573) 441-5481

#### WATER

PUBLIC WATER SUPPLY  
DISTRICT NO.5  
391 RANGELINE STREET  
COLUMBIA, MISSOURI 65205  
CONTACT: ROGER BALLEW  
(573) 474-8521

#### TELEPHONE

CENTURYLINK  
625 E. CHERRY  
COLUMBIA, MISSOURI 65205  
CONTACT: TIM DISHMAN  
(573) 886-3505

#### CABLE TV

MEDIACOM  
901 NORTH COLLEGE  
AVENUE  
COLUMBIA, MISSOURI 65201  
CONTACT: BOB BONER  
(573) 443-1535

#### ELECTRICITY

BOONE ELECTRIC  
COOPERATIVE  
P.O. BOX 797  
1413 RANGELINE STREET  
COLUMBIA, MISSOURI 65205  
CONTACT: DOUG GARDNER  
(573) 881-0828

THIS DOCUMENT HAS BEEN ELECTRONICALLY SIGNED, SEALED AND DATED.

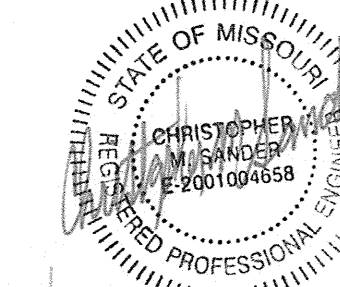

CHRISTOPHER M. SANDER  
MD E-2001004658  
SEPTEMBER 28, 2015

SURVEY AND PLAT BY  
A CIVIL GROUP  
CORPORATE NO. 2001006116

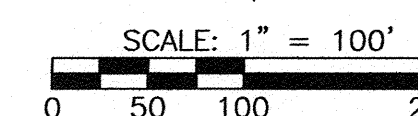

BEARINGS ARE REFERENCED TO GRID NORTH OF THE MISSOURI STATE PLANE COORDINATE SYSTEM (CENTRAL ZONE), OBTAINED FROM GPS OBSERVATION.

**A CIVIL GROUP**  
CIVIL ENGINEERING - PLANNING - SURVEYING  
3401 BROADWAY BUSINESS PARK COURT  
SUITE 1105  
COLUMBIA, MO 65203  
PH: (573) 817-5750, FAX: (573) 817-1677  
MISSOURI CERTIFICATE OF AUTHORITY: 2001006116

# THE VINEYARDS, PLAT NO. 2

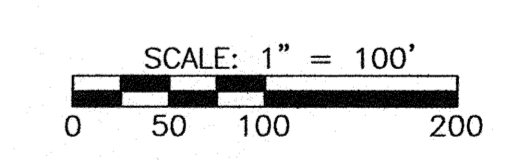
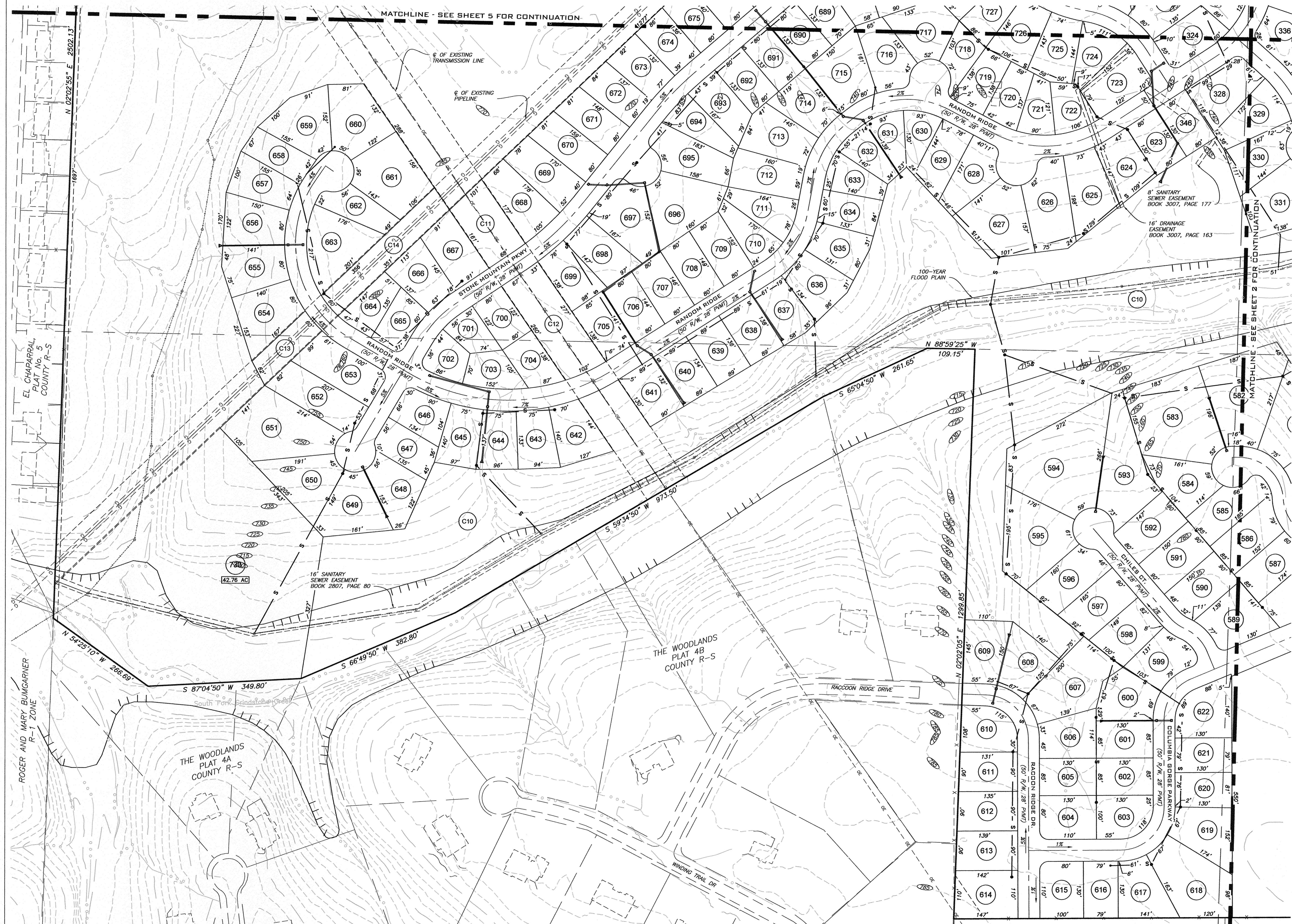

THIS DOCUMENT HAS BEEN ELECTRONICALLY SIGNED, SEALED AND DATED.



CHRISTOPHER M. SANDER  
 MO E-2001004658  
 SEPTEMBER 28, 2015  
 SURVEY AND PLAT BY  
 A CIVIL GROUP  
 CORPORATE NO. 2001006116

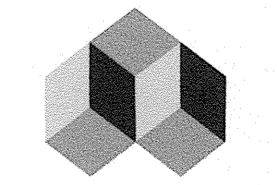

**A CIVIL GROUP**  
 CIVIL ENGINEERING - PLANNING - SURVEYING  
 3401 BROADWAY BUSINESS PARK COURT  
 SUITE 105  
 COLUMBIA, MO 65203  
 PH: (573) 817-5750, FAX: (573) 817-1677  
 MISSOURI CERTIFICATE OF AUTHORITY: 2001006116

# THE VINEYARDS, PLAT NO. 2

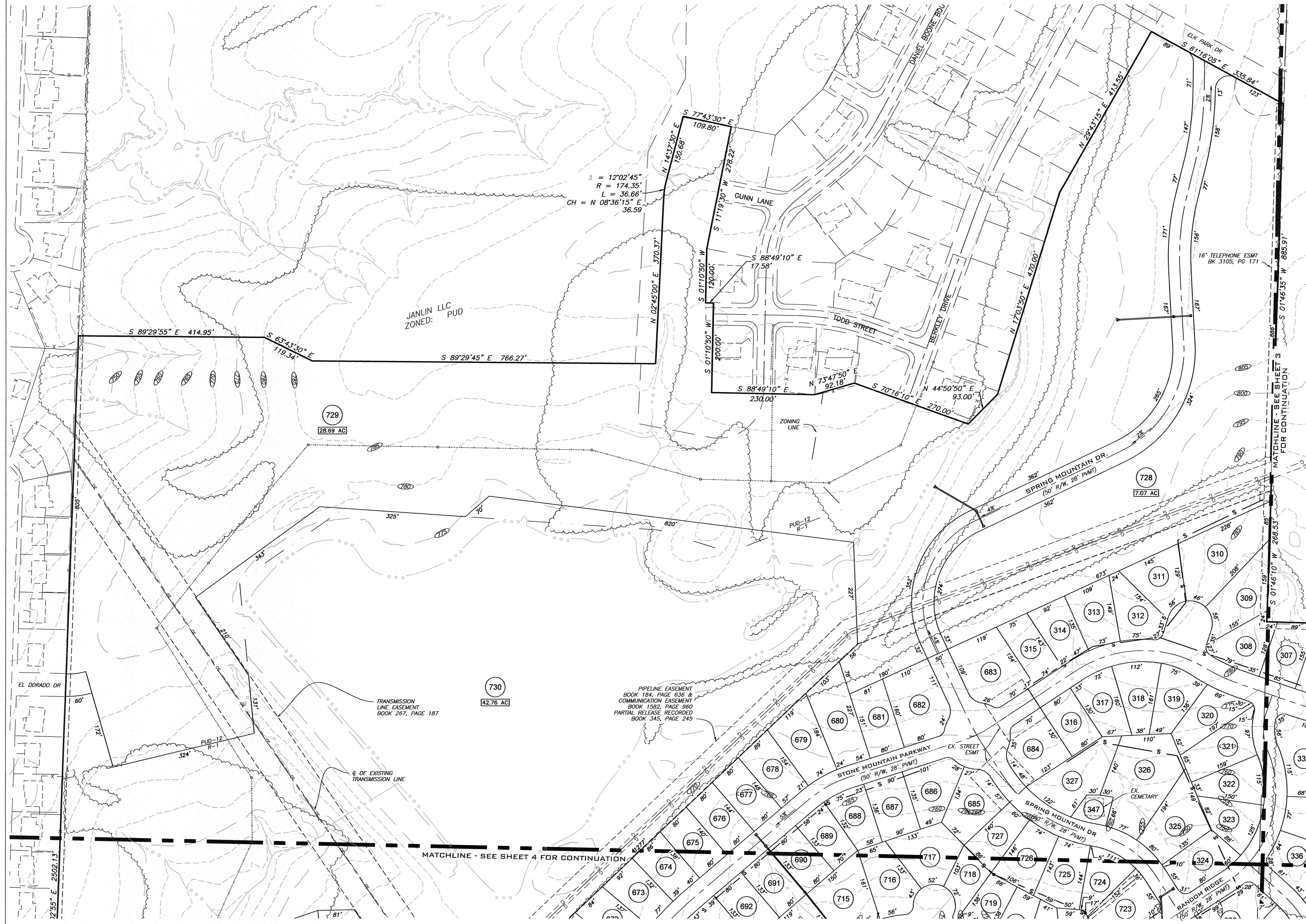

$\Delta = 12^{\circ}02'45''$   
 $R = 174.35'$   
 $L = 36.66'$   
 $CH = N 08^{\circ}36'15'' E 36.59'$

PIPELINE EASEMENT  
 BOOK 184, PAGE 636 &  
 COMMUNICATION EASEMENT  
 BOOK 1582, PAGE 960  
 PARTIAL RELEASE RECORDED  
 BOOK 345, PAGE 245

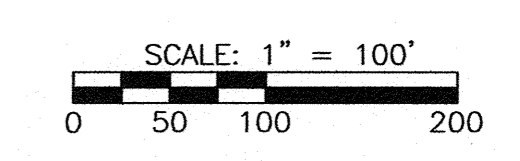

THIS DOCUMENT HAS BEEN ELECTRONICALLY SIGNED, SEALED AND DATED.

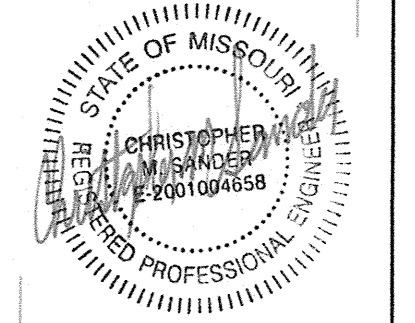

CHRISTOPHER M. SANDER  
 MO E-2001004658  
 SEPTEMBER 28, 2015  
 SURVEY AND PLAT BY  
 A CIVIL GROUP  
 CORPORATE NO. 2001006116

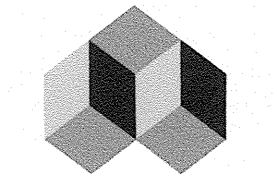

**A CIVIL GROUP**  
 CIVIL ENGINEERING - PLANNING - SURVEYING  
 3401 BROADWAY BUSINESS PARK COURT  
 SUITE 105  
 COLUMBIA, MO 65203  
 PH: (573) 817-5750, FAX: (573) 817-1677  
 MISSOURI CERTIFICATE OF AUTHORITY: 2001006115