

**OPERATIONS AGREEMENT
2017 TRUE FALSE FILM FESTIVAL**

This agreement between the City of Columbia, Missouri (“City”) and the Ragtag Film Society (“Ragtag”) is entered into on the date of the last signatory noted below.

The parties agree to the following provisions for the operation of the 2017 True False Film Festival (“T/F Film Fest”):

1. T/F Film Fest will partner with Columbia Public Works Transit Division to provide free rides on all COMO Connect fixed bus routes open to the public, including pass holders, March 2-5, 2017, during normal operating bus hours. Columbia Public Works Transit Division will also provide free rides on an additional bus route downtown with extended hours March 2-5, 2017, designed especially around film festival locations. Columbia Public Works Transit Division will install temporary signage at all of the T/F temporary bus stops and the T/F Film Fest will provide and install shelters for each of the six stops. T/F Film Fest will design, print, and install advertising on two select COMO Connect buses starting as early as January 1, 2017. Columbia Public Works Transit Division will design and print pocket guides for bus service to be distributed by T/F Film Fest. (Exhibit C)
2. The True/False Film Fest will be held on March 2 – March 5, 2017 from 9 a.m. until 1 a.m. daily for its fourteenth edition. Set-up and teardown for the event may occur February 24 – March 2, 2017, from 8 a.m. until 10:00 p.m. daily; March 6, 2017, from 8 a.m. until 10 p.m.; and, March 7 - 9, 2017 from 9 a.m. until 6 p.m. daily.
3. T/F Film Fest shall comply with the festival layout set forth on the attached map, marked Exhibit A, which is attached to and made a part of this agreement.
4. T/F Film Fest shall work with the City of Columbia Police, Fire, and Public Works Departments to develop a Traffic Management and Transportation Plan. Traffic flow impact will be reviewed by the Police Department. The Police Chief (or the Chief’s designee) may require an engineered traffic plan if warranted, or a review of the traffic flow impact by the City Traffic Engineer.
5. T/F Film Fest shall secure all necessary City, County and University permits required in connection with the festival except those as outlined in item 9.
6. T/F Film Fest shall provide four (4) staff to assist in traffic monitoring at 10th and Cherry and staffing the booth at Short Street Garage on Friday, Saturday and Sunday for eight (8) hours each day.
7. T/F Film Fest is authorized to close 9th Street, between Locust and Elm Streets for the duration of the event beginning at 10:00 a.m., Thursday, March 2, 2017 until 11:59 p.m. Sunday, March 5, 2017 (Exhibit A). The Police Department will provide necessary traffic management assistance during the parade as resources allow.

- a. T/F is allowed to construct art exhibitions inside the closure area as set forth in the Supplemental Materials attached to this agreement (Exhibit B). These installations may be inspected by the Building and Site Development Department as deemed necessary by the Department Representative.
8. Alcohol. T/F has requested permission to provide alcoholic beverages as part of the operations agreement. All alcohol at the Festival shall comply with the following provisions:
 - a. Waiver of alcohol is contained to the area defined by the 20x60 tent to be set up by A-1 Rentals as outlined in the Supplemental Materials (Exhibit B) and Map/Diagram (Exhibit A) and is valid on Thursday, March 2, 2017 from 5:30 p.m. until 7:30 p.m.
 - b. Alcohol service is limited to two (2) alcoholic beverages per consumer per transaction.
 - c. Alcoholic beverages shall not be served in glass bottles or glass containers. Alcoholic beverages shall be served only in clear, plastic and/or commemorative cups, plastic bottles or cans. Alcoholic beverages shall be served in containers that are distinctively different from each other.
 - d. T/F bartenders and festival staff are responsible for insuring that ID's are checked before serving alcoholic beverages. T/F will have festival staff and security at all entry and exit points of the alcohol areas insuring open containers do not leave the area.
 - e. All servers and event staff in the alcohol service areas are required to complete SMART training offered online by the University of Missouri on alcohol awareness and the restrictions listed above. Persons serving alcohol are required to carry a server certificate issued by the Department of Health and Human Services.
 - f. Intoxicated individuals will not be served.
 - g. T/F shall post signage stating "No Alcohol Permitted Past this Point" at all exit points of the alcohol areas.
 9. T/F Film Fest will secure permission from Copeland Law Firm to install a large-scale projection piece, called the Great Wall. The City shall turn off the city street light on the Southwest corner of 9th and Broadway during the projections hours: Thursday, Friday, Saturday and Sunday March 2 – 5, 2017 from 7 p.m. until 11 p.m.
 10. T/F Film Fest shall be allowed to install signage/banners as outlined in the Supplemental Materials for True/False Special Use Application marked Exhibit B.

11. T/F Film Fest shall be allowed to install temporary art and signage beginning Monday, February 27, 2017 and removed no later than Tuesday, March 7, 2017 as outlined in the Supplemental Materials for True/False Special Use Application marked Exhibit B:
 - a. Neon Sculpture (“All That Is Possible Is Real”) at 9th and Alley A
 - b. Mineral Sculptures on I-beams at the East end of Alley A
 - c. Globe Sign on 10th/Cherry Parking Garage
 - d. Light sculpture at Tiger Hotel end of alley
 - e. The Tunnel at 9th and Elm
 - f. Parklet on 9th Street
 - g. Bus Shelters
 - h. Public Living Room “Exposed to the Elements” on 9th St between Elm and Locust
 - i. Giant Connect Four game on 9th between Elm and Locust
 - j. Stacked cars with projection “Empire Drive In Project” on 9th between Elm and Locust
 - k. Wild Seed: Mobile Field Museum & Apothecary on 9th between Elm and Locust
 - l. Corner Playhouse sign on 9th between Elm and Locust

12. T/F Film Fest shall maintain ADA accessibility throughout the festival footprint.

13. The City shall provide:
 - a. Additional recycling and trash services throughout downtown during the four days of the festival. Utilities-Solid Waste Division will set up trash/recycling receptacles by March 2, 2017 and remove the receptacles on March 6, 2017. Sidewalk trash/recycling receptacles will be placed at the following locations: near Blue Note/Coffee Zone; near Ragtag/Uprise; at the corner of Walnut and Orr, by the 2017 T/F Box Office; by Tiger Hotel; throughout Alley A, between Hitt and 8th; at corner of Cherry and Hitt by the parking garage; 9th Street/Locust at Yogo Luv; 9th/Elm by United Methodist Church; corner of University and Hitt; and T/F Party Space (TBD). A recycling drop-off container will be placed on Cherry Street between 8th and 9th Streets during the event. In addition to the trash/recycling receptacles, one dumpster shall be placed at the T/F Lab, at 1600B Business Loop 70 East for four months (mid – December through mid- April); the City will cover the cost of two months (mid-February through mid-April 2017). T/F requests a dumpster for the Party Space (TBD) exact dates to be confirmed once space availability is confirmed by T/F staff – these costs will be covered by T/F Organization. City will provide 20 X-frame receptacles for use in film venues and other spaces at no additional cost.

 - b. Columbia Center for Urban Agriculture has permission to haul food waste during the festival weekend.

 - c. Free admission for festival pass holders, attendees, and the public on CoMo Connect during the four days of the festival. Hours outlined below.

- d. Advertising on the outside of CoMo Connect buses beginning January 1 until March 6, 2017 (same size as last year; TF will provide the signage).
- e. Twenty (20) reserved parking meters 02/27/2017 – 3/07/17 (see below):
 - C1011/C1009 - Cherry Street
 - U932 – corner of University & Hitt
 - 8S16/8S14 - 8th St by Tiger Hotel
 - TS211/TS213 – 200 Block of S 10th Street
 - TS203 – 200 Block of S 10th Street
 - L808/L810
 - L811/L809 - on Locust near MO Theatre, for two Tech-related vehicles
 - L812/L814
 - 9S21/9S19 – 0 Block of South 9th
 - 9N13 – in front of Blue Note
 - 1 - TBD – Musician’s Lounge
 - 2 - TBD
- f. One Thousand Dollars (\$1,000) in CoMo Park cards (50 cards with \$20 on each).
- g. Advertising at the airport through poster display, banner, video monitor ads, and ads at flymidmo.com.
- h. General assistance as outlined on CEC request.
- i. In lieu of permits secured through the City of Columbia Community Development Department, the TF Film Fest is approved to place signage and art as proposed in Exhibit B on private property and in the right of way.

In exchange, the festival would offer a Lux sponsorship package valued at \$12,000, which includes:

- a. Full-page ad in the festival program
- b. Logo placement on the "Navigating T/F" page of the festival program
- c. Logo placement, with hyperlink, on the "Getting Around" section of the festival website, as well as on the sponsors listing on the website
- d. Logo placement on festival print ads in the remaining Columbia Daily Tribune ads available and in the Inside Columbia Magazine ads.
- e. Eight (8) Lux passes to the festival

- f. Opportunity to include an item in Super and Silver passholder "swag" bags (approximately 300); item must have value and not be solely promotional.
14. T/F Film Fest shall obtain the following insurance in connection with the festival:
- a. T/F Film Fest shall take out and maintain for the festival such Comprehensive General Liability insurance as shall protect it from claims for damages for personal injury including accidental death as well as from claims for property damage which may arise from festival operations, whether such operations be by itself or by anyone directly or indirectly employed or otherwise working for it. The amount of insurance shall be not less than \$2,000,000.00 combined single limit for anyone occurrence covering both bodily injury and property damage, including accidental death. The City of Columbia must be named as an additional insured for the duration of the event including event set-up and break-down.
 - b. T/F Film Fest shall maintain for the festival Automobile Public Liability insurance in an amount not less than \$2,000,000.00 combined single limit for any one occurrence covering bodily injury, including accidental death and property damage, to protect itself from any and all claims arising from the use of motor vehicles operated by it in connection with the festival. The City of Columbia must be named as an additional insured for the duration of the event including event set-up and break-down.
 - c. Participants in all related activities, including the parade, must be covered by the organizers insurance or provide insurance acceptable to the City.
 - d. To the fullest extent not prohibited by law, T/F Film Fest shall indemnify and hold harmless the City of Columbia, its officers, agents and employees from and against all claims, damages, losses and expenses (including but not limited to attorneys' fees) arising by reason of any act or failure to act, negligent or otherwise, of T/F Film Fest, of anyone directly or indirectly employed by or otherwise working for T/F Film Fest, or of anyone for whose acts T/F Film Fest may be liable, in connection with the festival. This provision does not, however, require T/F Film Fest to indemnify, hold harmless, or defend the City of Columbia from City's own negligence.
 - e. No later than January 23, 2017 T/F Film Fest shall furnish City with a certificate of insurance that names City as an additional insured in the amounts required in this agreement and that requires a 30-day mandatory cancellation notice.

IN WITNESS WHEREOF, the Parties, through their duly authorized representatives, have executed this Agreement effective as of the date of the last party to execute the same.

CITY OF COLUMBIA, MISSOURI

By: _____
Mike Matthes, City Manager

Date: _____

ATTEST:

Sheela Amin, City Clerk

APPROVED AS TO FORM:

Nancy Thompson

RAGTAG FILM SOCIETY

By: _____
Tracy Lane, Executive Director

Date: _____

ATTEST:

STREET CLOSURE DETAIL - see pg 4 for open container area detail

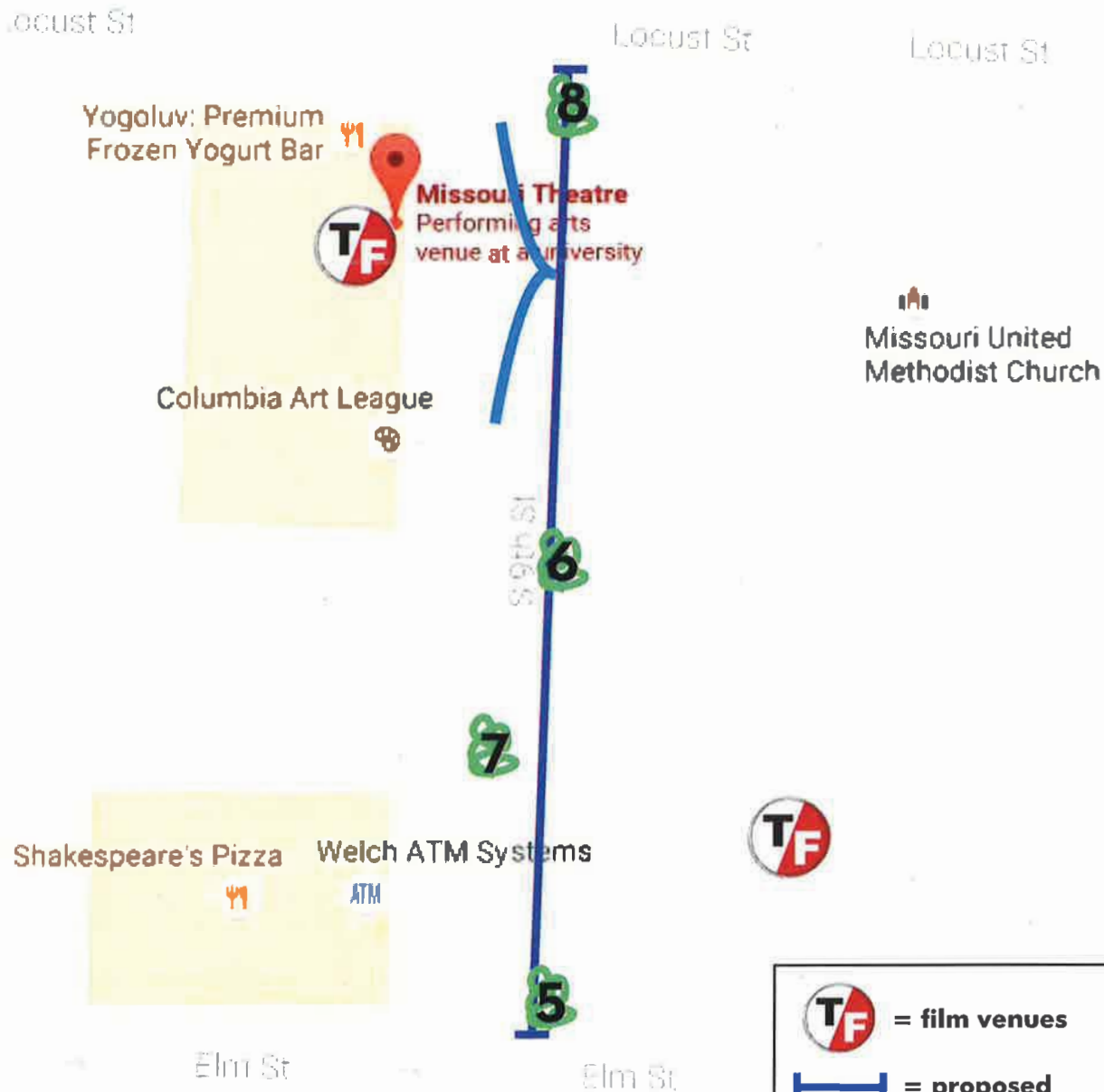

 = film venues

 = proposed street closure

 = ART
(please note that all Art installations planned for the street closure area will fit within a parking space or two parking spaces)

 = proposed tent location (approximate)

OPEN CONTAINER AREA LAYOUT

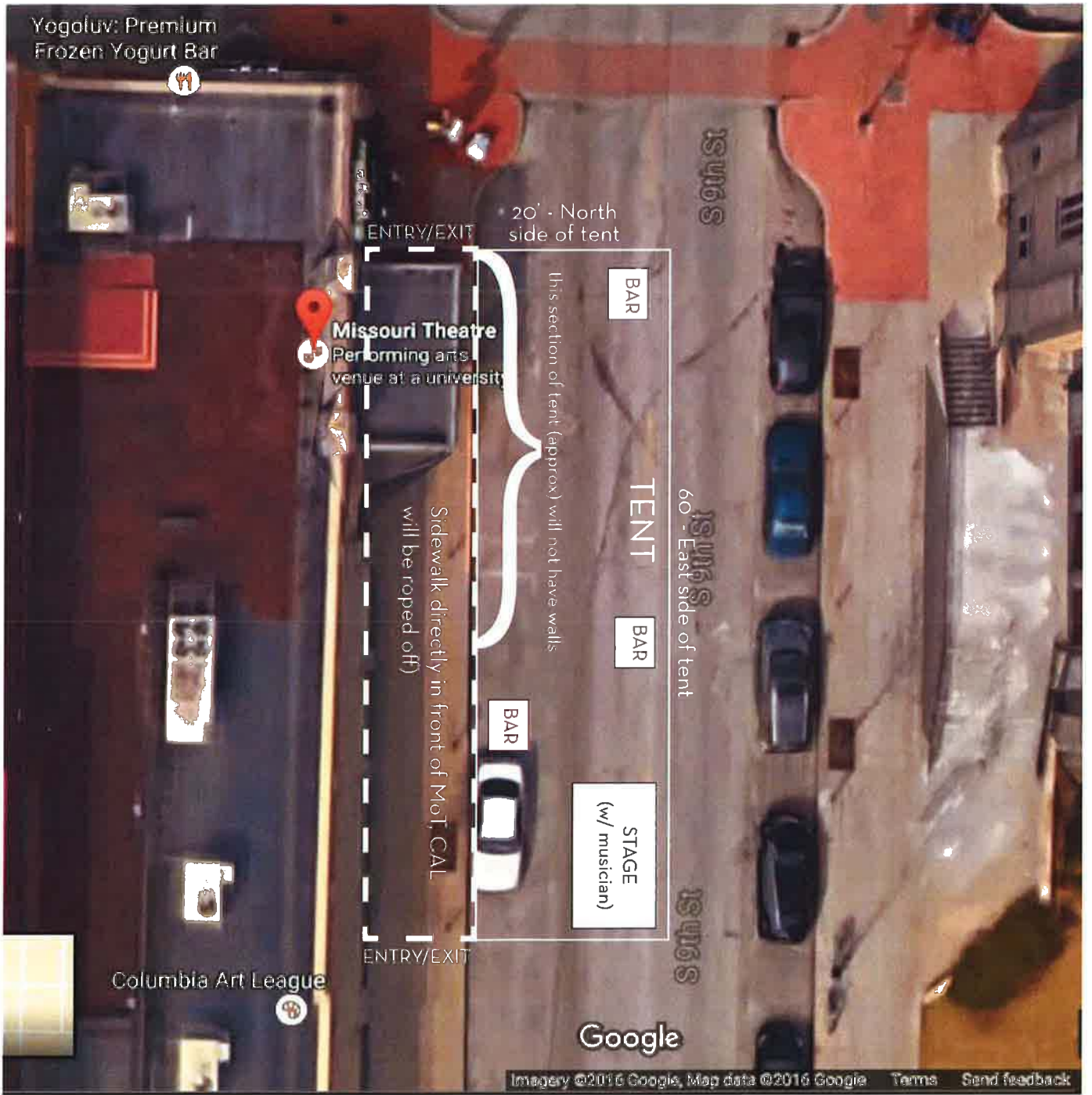

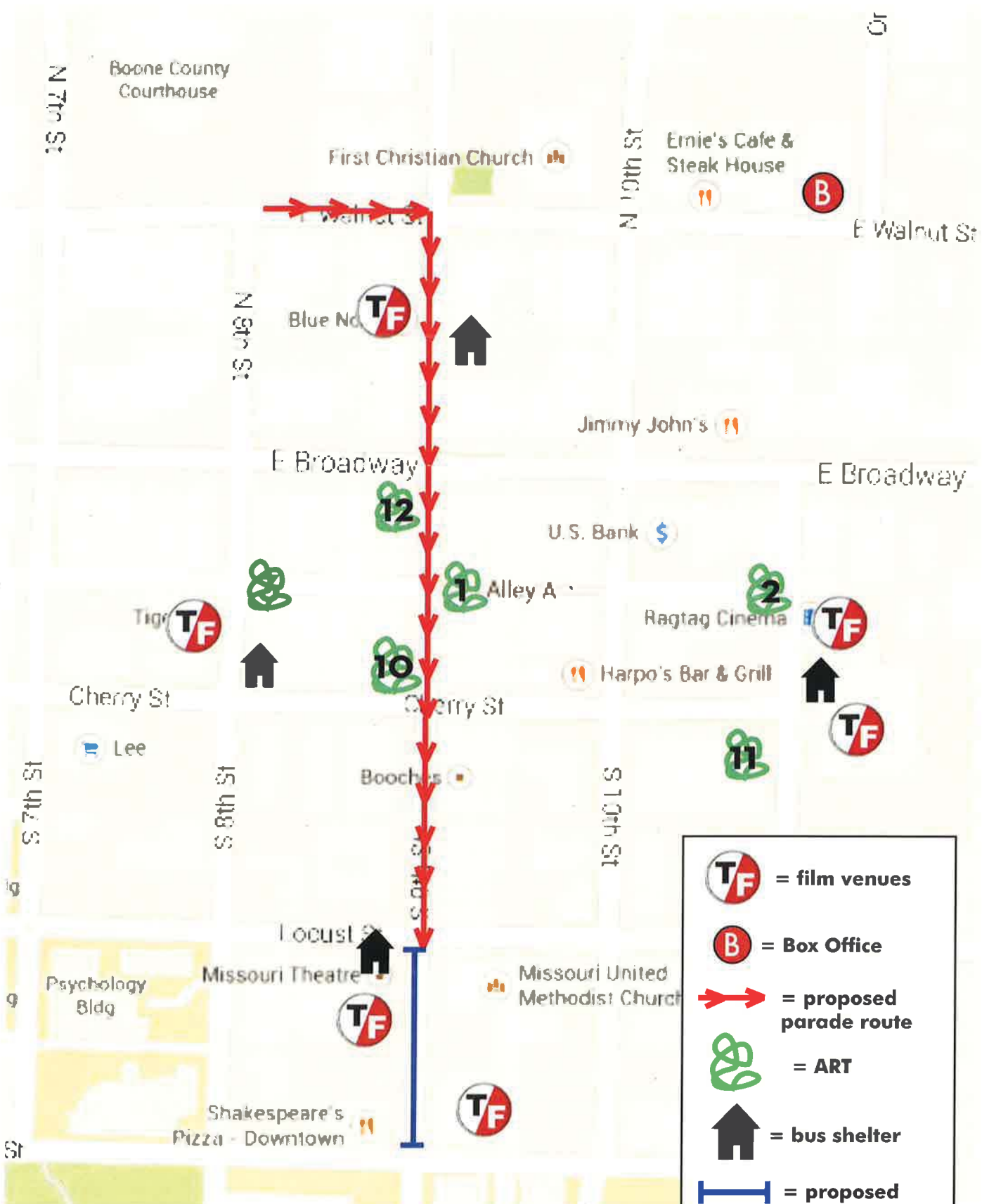

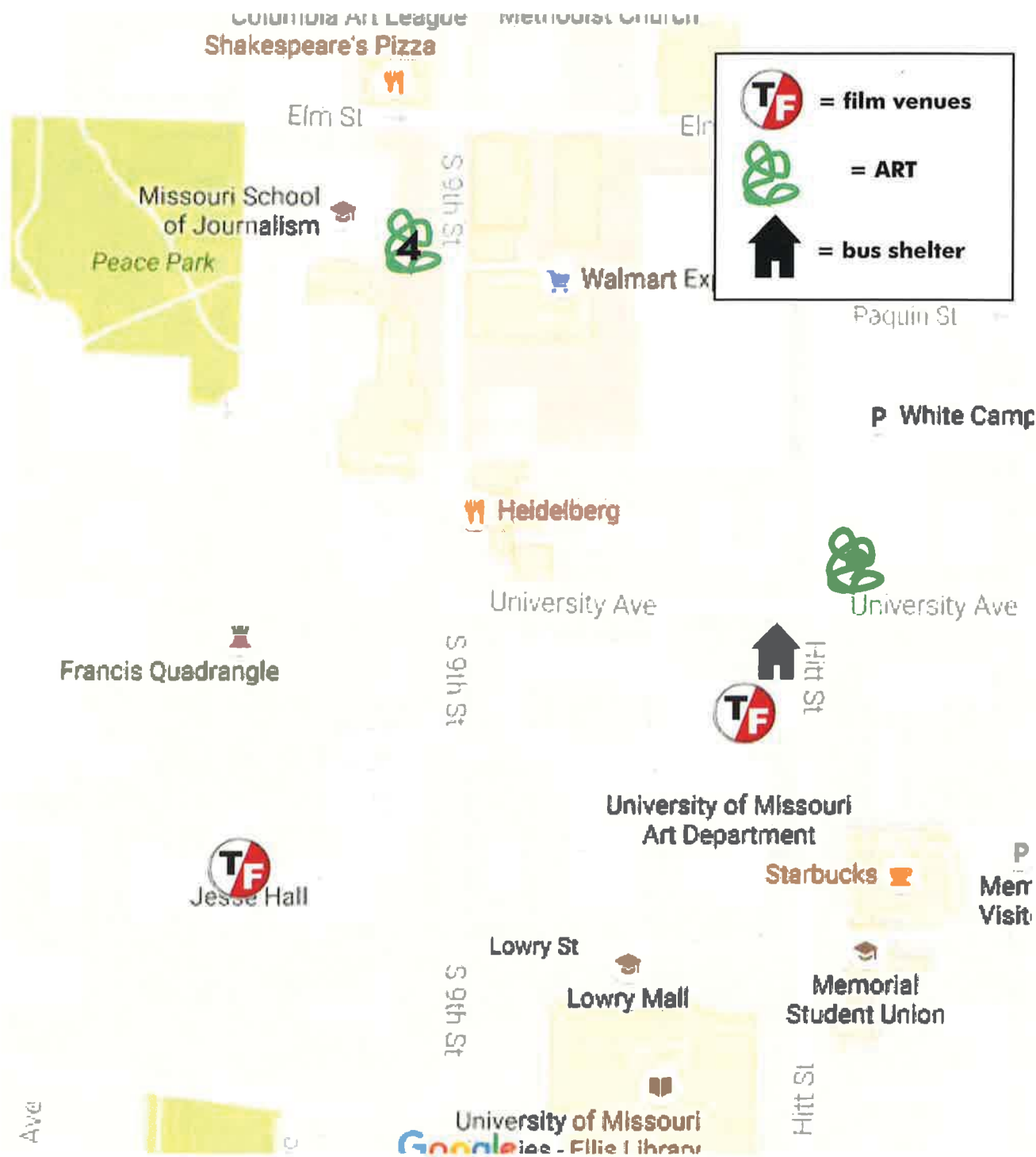

	= film venues
	= Box Office
	= proposed parade route
	= ART
	= bus shelter
	= proposed street closure

(see page 3 of this map for a detailed layout of plans for street closure area)



 = film venues

 = ART

 = bus shelter

 Jesse Hall



 Hitt St

 Merr Visit

TF = film venues

B = Box Office

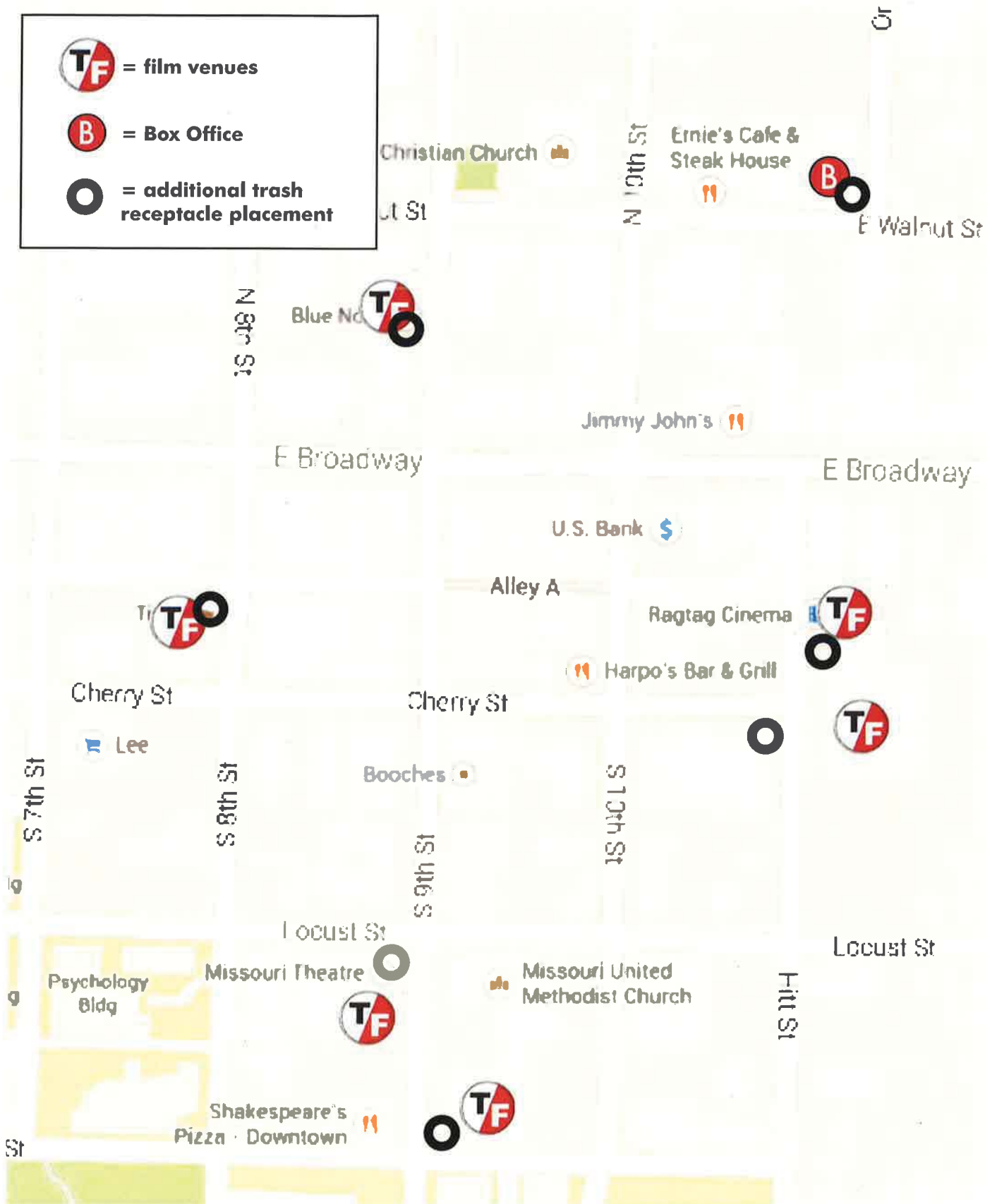
○ = additional trash receptacle placement



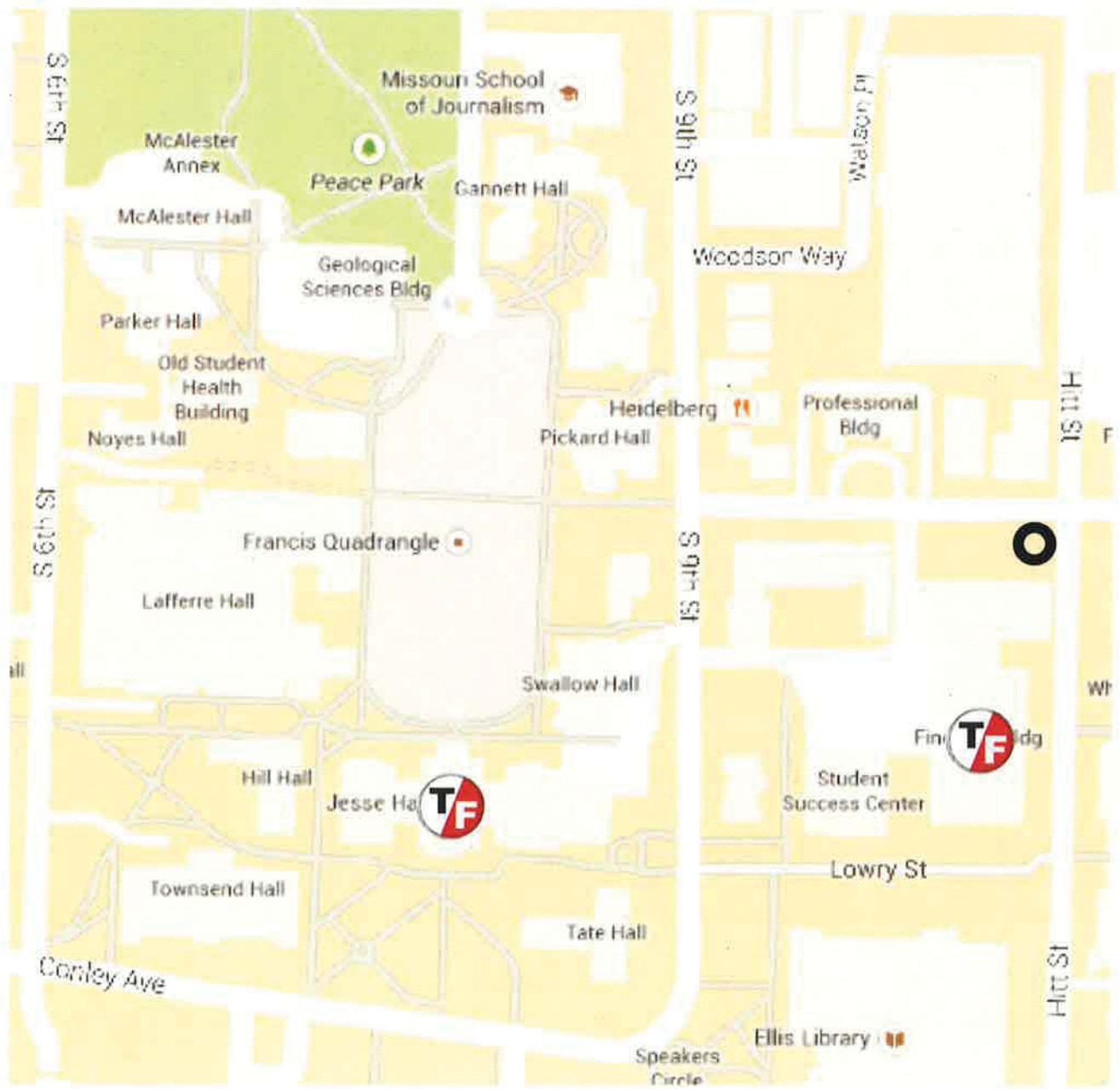

SUPPLEMENTAL MATERIALS FOR TRUE/FALSE SPECIAL USE APPLICATION FORM

Set Up and Tear Down dates/times: February 24 - March 2, 2017, 8 AM - 10 PM daily; March 6, 2017, 8 AM - 10 PM; March 7 - 9, 2017, 9A - 6P.

Event dates/times: March 2, 2017, 4 PM - 1 AM; March 3 - 5, 2017, 9 AM - 1AM daily.

Detailed description of event: The True/False Film Fest will run March 2 - 5, 2017, for its fourteenth edition. The festival conducts approximately 140 film screenings at 8 Columbia locations; those locations are: The Picturehouse, located inside the Missouri United Methodist Church on 9th Street; the Missouri Theatre Center for the Arts; The Blue Note; Ragtag Cinema; the Forrest Theater at the Tiger Ballroom; Jesse Auditorium; Rhynsburger Theatre (on MU campus); and the Globe Theater, located at the First Presbyterian Church on Hitt Street. Each screening is preceded by a short musical performance. In addition, the festival puts on 15 special events; 1 parade; and 12 public art installations (see below for details), which includes 1 large sign that we also consider to be art (see below for details). Additionally, the fest has a partnership with Columbia Public Transit to provide free rides to the public, including pass-holders, on a special T/F CoMO Connect route during the festival (see attached document, "CoMOConnect-scheduledetails2017.pdf," and/or Shay Jasper at Public Transit for details; final TF bus route forthcoming). Columbia Public Transit will be installing temporary signs at all of the T/F CoMO Connect stops, and T/F is working with Architectural Design students at MU to build and install 6 temporary bus shelters for selected stops (see below and attached for details; relevant attached documents are all marked "Bus Shelter").

A map of the festival area with all venues marked is attached (TF_map2017.pdf); art installations and bus shelters intended for the 2017 Fest are marked, and a map detailing the plan for the street closure (see below) is included.

A note about late-night parties -- as always, we will inform the Police Department of any late-night events (date & time, location, etc) that we will be hosting. All parties are private events.

Street Closure, Parade, and Tent

New in 2017, we would like to close the block on 9th Street between Elm and Locust for the entire festival weekend (in past years, we have just closed that block during the parade/Reality Bites on Friday evening). Our reasons for this are as follows. In order to expand the capacity for the Jubilee (our opening night event), we came up with the idea of placing a tent on 9th Street outside the Missouri Theatre; this would require the street to be closed during that event. As in prior years, we would still intend to request a street closure for the parade and Reality Bites, held on Friday. We determined that it made more sense to request a longer street closure than to request two separate street closures (one Thursday, one Friday). Once we came to that conclusion, we decided that a closure for the entire weekend could precipitate an increased celebratory, community atmosphere, and that we could foster that atmosphere. To that end, we would like to install up to four interactive public art pieces on that block, to encourage community members and festgoers to spend time in that block throughout the festival weekend. Details about these pieces are included later in this document (see pages 10-13). We are in the process of collecting signatures from all the businesses on the proposed street closure area with approval; we will secure all needed signatures and submit the completed form before the Special Use Committee's December meeting. If needed, we will adjust our plan, and will inform the Committee immediately if that proves

necessary.

As noted above, we will have a tent installed outside the Missouri Theatre for the Jubilee on Thursday, March 2. This tent will measure 20'x60', and will be installed on Thursday by 10A, and taken down on Friday by 10A. This tent will be professionally installed by A1 Party & Event Rental; they will handle the tent permit paperwork. The tent will have walls on all sides; on the side facing Missouri Theatre, there will be a large section without walls that will serve as the primary entry/exit. We plan to rope off the sidewalk between the tent entry/exit and the main Missouri Theatre doors so that we can better manage passholder entry/exit. The tent and adjacent sidewalk area will be open to Lux passholders and above only.

As noted above, the parade will take place on Friday, March 3, 2017, beginning at 5:15P, and is scheduled to complete the journey by 6P. The parade will start at the Boone County Courthouse Square on Walnut and 8th St. It will traverse to 9th St and travel 4 blocks to Missouri Theater (between Locust and Elm Streets). Pending City approval of the street closure request described above, there will be a block celebration kick off event on 9th Street (between Locust and Elm Streets) between 5:30P and 7P. We would also like to request police assistance for the 9th and Broadway intersection and/or the 9th and Cherry intersection during the parade, if available.

Open Container Waiver

We are requesting a waiver of the open alcohol container ordinance for Thursday, March 2, 2017, from 5:30P - 7:30P. We are working with the Craft Beer Cellar to obtain the necessary permits for doing so (temporary caterer's/liquor license). Included in the enclosed TF map (TF_map2017.pdf) is a layout of our proposal for the open container area; we would be asking for an open container waiver for the interior of the 20x60 tent and the section of the sidewalk between the tent area and the main doors to Missouri Theatre (please refer to map as well).

Trash, Recycling, and Compost

We have also requested additional trash and recycling receptacles to help assuage littering during the weekend. Pending approval of True/False's agreement with the City of Columbia, Public Works will, as in previous years, set and remove the receptacles for us in 2017; we request that they be set on March 2, and removed on March 6, and that they be set at the following locations: Blue Note/Coffee Zone; by Ragtag/Uprise; at corner of Walnut and Orr, by Sager Braudis Gallery (the 2017 TF Box Office); by Tiger Hotel; throughout Alley A (between Hitt & 8th); at corner of Cherry & Hitt by parking garage; by Yogo Love on 9th; at 9th & Elm by MOUMC; at corner of University and Hitt, by Rhynsburger; and at the TF Party space, location TBD. We also requested a dumpster, to be placed at the TF Lab (our workspace, located at 1600B Business Loop 70 East) for four total months (mid-Dec through mid-April); pending approval of our agreement with the City of Columbia, the City will cover the cost of two of those months (mid-February through mid-April, 2017). T/F also secures a dumpster for the Party Space (location TBD), which we cover all costs for. Finally, Solid Waste has agreed to lend TF 20 X-frame receptacles for use in our film venues and other spaces.

Deputy City Manager John Glascock has granted permission for TF and CUA to haul food waste during the festival weekend, pending approval of this application.

Parking meter cloth covers

As in prior years, we will also be utilizing several parking meters; again, pending approval of our

agreement with the City of Columbia, cloth bags will be provided for 23 parking meters. All bags will be used for art installations and/or loading/unloading/parking Fest vehicles during T/F set up, the fest itself, and break down. Two on Cherry St near Ragtag Cinema; 6 on 9th St between Locust and Elm; 3 on 10th Street on the east side of MOUMC (T/F Picturehouse); 2 on 8th Street across from Tiger Hotel; 2 at the corner Locust & 9th on the NW side of Locust Street; 4 near the corner of Locust & 9th on the SW side of Locust; 1 at the corner of University & Hitt Street, near Rhynsburger Theatre; 2 in front of Kaldi's for a parklet; and 1 at the Musician's Lounge (location TBD). Parking meter numbers (note: some are double meters; some single): 9S200, 9S202, C1009, C1011, 9S210, 9S212, 9S217, 9S220, U932, 8S14, 8S16, TS211, TS213, TS203, L808, L809, L810, L811, L8212, L814, 9S19, 9S21, 1-TBD (Musician's Lounge). If the street closure that we have requested is granted for the whole weekend, we may not need the following meter covers: 9S200, 9S202, 9S210, 9S212, 9S217, 9S220.

Signs

In addition to the "Globe" sign (see below), we will also have smaller directional and informational signs at our venues.

Box Office banners:

The Berry Building (Walnut St.) will have (3) vertically oriented fabric banners, each approximately 30" wide x 12' tall, attached to the brick wall above the street-level picture windows and between the upper story windows. We have secured permission from the building owner and tenants to do so.

Vinyl banners:

There will be a 118"x 42" banner at the First Presbyterian Church; a 70"x42" banner on the patio fence at Ragtag; and (2) banners at the Missouri United Methodist Church, one 18'6" x 28", the other 11' x 26".

Sandwich boards:

The following venues will have standard-size sandwich boards set outside for purposes of identifying events/films: the Blue Note, the Globe (First Presbyterian), Ragtag, Forrest (Tiger Hotel), Picturehouse (MOUMC), Missouri Theatre, Rhynsburger Theatre (on MU campus), and Jesse Auditorium. Music showcase events (Cafe Berlin, Mojoes) will use a larger sandwich board sign (24" x 48") for listing music line-ups. There will be (2) smaller "no parking" sandwich board signs for use by the First Presbyterian Church.

Temporary Art Installation Proposals

We have numbered each of the proposals below; the numbers correspond with the numbers listed on the TF map, included in our materials.

Alley A

1. Neon Sculpture ("All That is Possible is Real") at 9th & Alley A

Description

"All That is Possible is Real" is a piece by Texas-based artist Alicia Eggert. The piece consists of a neon sign whose words flash on and off between two similar but different messages: "All that is real is possible" and "All that is possible is real." The sign is inspired by a passage from the philosopher Immanuel Kant's *The Logic of Pure Reason*.



A photo of the piece as installed for T/F 2016.

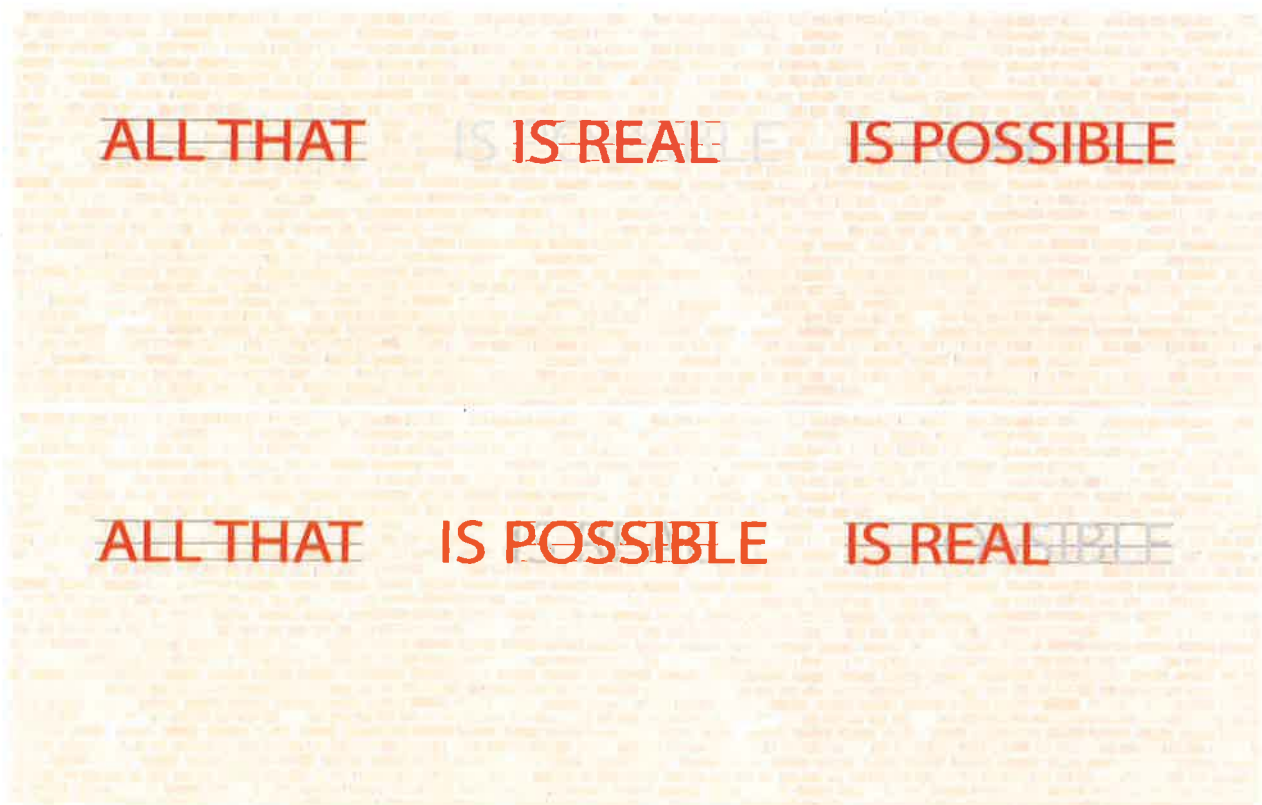

Artist's rendering of the piece; the neon will flash between the two statements.

Construction

The sign has been constructed in such a way as to be easily installed and later disassembled at the conclusion of the festival. It consists of 18" tall red neon letters that were fabricated by Neon Time, a neon fabricator located in St Charles, MO. The letters will be mounted to wooden rails that will be pre-assembled and painted. The rails will be anchored to the brick wall at a height of 8 feet, in order to keep the fragile glass letters out of reach. The neon transformers and custom controller will be housed in boxes housed in the offices located immediately above the piece (their windows are easily accessible). Note that the below image indicates that the boxes will be placed on the ground; this was an idea proposed before the 2016 festival that we abandoned, and we will once again place the boxes in the offices above.

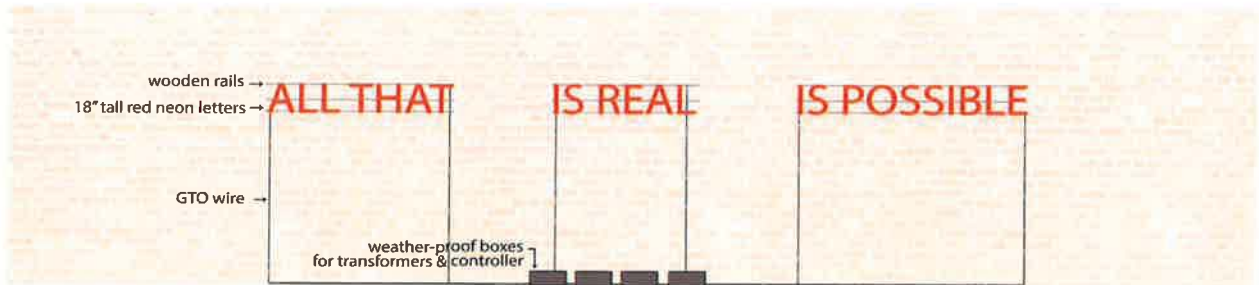

Artist's rendering of construction/installation plan.

Installation timing

We plan to install the sculpture no earlier than Monday, February 27, 2017, and no later than Wednesday, March 1. We will remove it on Monday, March 6, or, if weather is a concern, on Tuesday, March 7.

2. Light sculptures near I-beams

"Mineralogy 101" is a series of suspended sculptures made by local artist Carrie Elliott. The installation will be comprised of approximately 12 three-dimensional lit sculptures of minerals. Sculptures will be based on museum-quality samples of crystals and mineralogical samples; minerals may include amethyst, quartz, pyrite, malachite, turquoise, staurolite, calcite, copper, halite, and tourmaline; the specific list may change. Minerals will be constructed to be lightweight, yet durable. Each sculpture will have slightly different dimensions and will not be reproduced to scale, but will generally be 2-3 feet in diameter. The three-dimensional sculptures will be composed of base forms covered in materials. Opaque minerals (such as pyrite) will be composed of wire bases, paper mache, and painted. Minerals that are translucent will be sculpted from wire, wood, and/or plastic bases, wrapped in layers of cellophane, packing tape, glue, and tissue paper and painted depending on the effect needed. The translucent minerals (amethyst, smoky quartz) will be lit with lightweight LED lights inside the sculptures. Sculptures will be coated using marine-grade sealant for long-term protection from the elements.

We will string aircraft cable between the Seoul Taco/Gunter Hans building and the Stephens building, and each mineral sculpture will be suspended from the cable. We will ensure that the sculptures are hung in such a way that they will not swing, bang into each other, or rip free from the aircraft cable. We are in the process of securing permissions from the building and business owners.

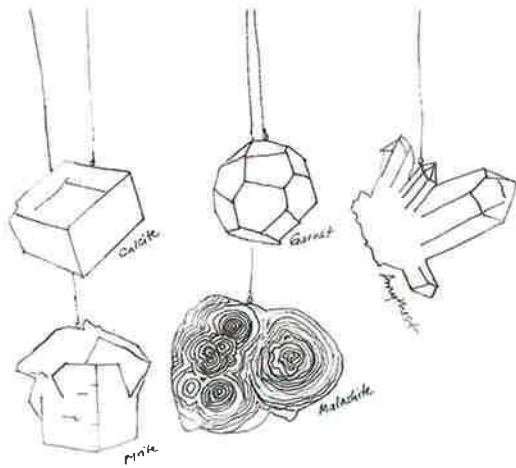

Artist illustration of potential minerals to be created.



Pyrite sculpture created by artist (day/night, respectively).

3. Light sculpture at Tiger Hotel end of alley

For the 2017 festival, we would like to once again install the light sculpture on the Tiger Hotel end of the alley. Below, we have included an image from TF 2016 to provide an idea of where/how the piece will be installed, as well as a description of the plan for installation. Obviously a big part of the location involves using the City parking garage located at 8th and Cherry; we hope that the City will be amenable to us once again utilizing the garage as we did in 2016, and as outlined below. Additionally, we have secured permissions from the building and business owners adjacent to where the piece will be installed.

The sculpture's clear dimensions are 8'x1'x1'. It will be suspended vertically in the Alley using a hydraulic lift. Once installed, its lowest point will exceed 15'.

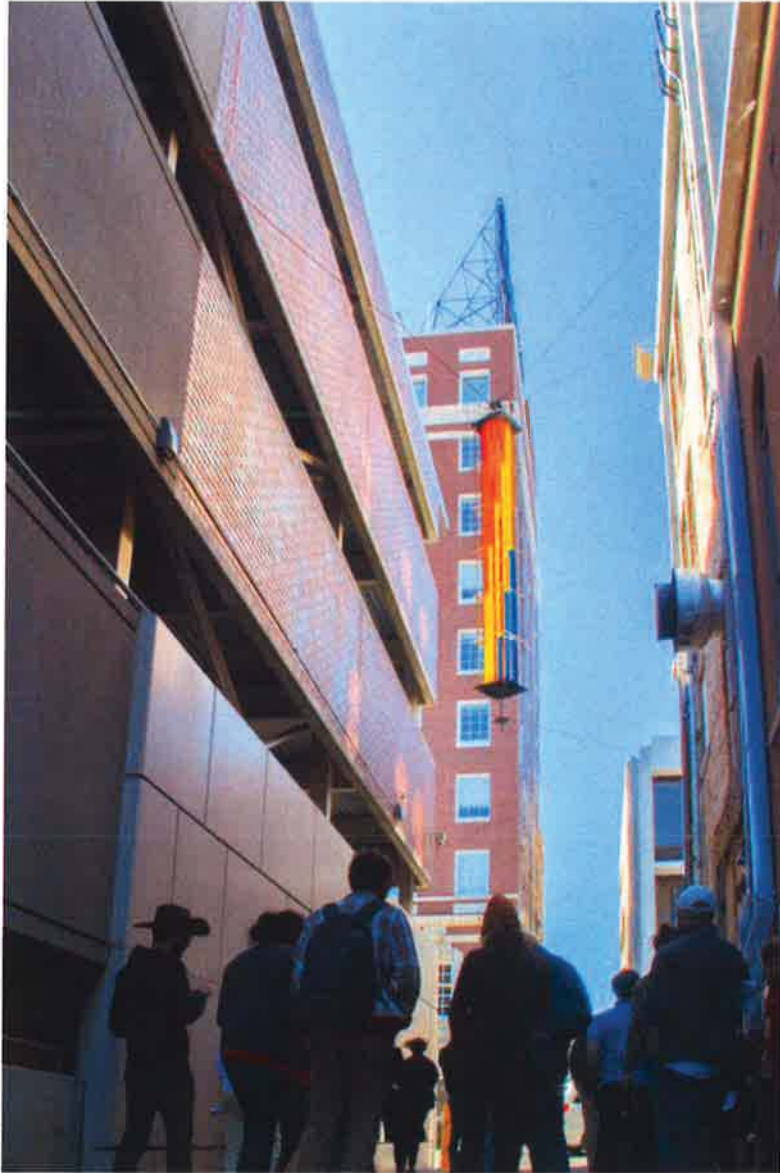

Piece as installed in 2016.

We plan to suspend the piece from cables between the City garage and the building across the alley. For the garage side attachments, we would use the big steel beams and various other suitable anchor points available on the parking garage. On the building across the alley, we will reuse existing masonry anchors and eye hooks, which we installed for the 2016 Fest. Cable harnesses are used on both top and bottom ends of the piece.



Taken from inside the parking garage, looking out onto alley.



Potential Lightbox Power Source

4. The Tunnel

In conjunction with the University of Missouri, in 2017 we will be installing a large archway (called "The Tunnel") on the sidewalk at the corner of 9th and Elm, as in 2014 and 2016.

As was the case in the prior years indicated, the Tunnel will be comprised of a series of large doorways connected in such a way that when viewed from the ends create a tunnel effect. While the door at the center will be perfectly plumb, the openings for the connecting doorways will step incrementally out of plumb. We added a uniform number of inches to each run of the sloped door jamb in such a way that when the installation is viewed from its end, the doorways will appear to twist from out of plumb, to plumb,

to out of plumb in an equal and opposite fashion.

Each doorway will be a combination of three parts:

1. A 4' x 8' sheet of $\frac{1}{4}$ " plywood, 2x4, and $\frac{1}{4}$ " plywood sandwich that has a "door header" cut and framed into it.
2. Another plywood and 2x4 sandwich that requires half a sheet of 4x8 plywood divided along its length that serves as one of the "door jambs."
3. A third plywood and 2x4 sandwich that serves as the other "door jamb."

The assembled pieces (header and jambs) will be aligned to stand as a door using a number of peg and hole joints. These jointed pieces will be locked, and the doorways connected by means of a ripped, 2' wide, 8' long, $\frac{1}{2}$ " sheet of plywood hung from the 12' height of the doorway, fastened with star-drive exterior screws to the outside edge of two consecutive doorways. The subsequent doorway in the series will be connected in a similar manner to the previous one on the edge opposite the former connection. In this manner, the doors will effectively accordion from one end of the archway to the other. In total, the installation will be comprised of 7 of these doorways. See photo below for visual reference.



The Tunnel as installed in 2014

We anticipate that set-up of The Tunnel will take place no earlier than Monday, February 27, 2017, and no later than Wednesday, March 1. We will take it down on Monday, March 6, or Tuesday March 7 at the latest.

9th Street closure Art

As noted elsewhere, we are hoping to close the block of 9th Street between Elm and Locust for the duration of the festival weekend. Rather than simply closing off the street, we wanted to make the space interesting and dynamic, for our passholders and ticketholders, and for the general public. To that end, we're working with four different artists to create a temporary sculpture garden, with interactive installations suitable for all ages and open to the public.

5. Public Living Room ("Exposed to the Elements") on 9th St. between Elm and Locust

Description

Local artist Taylor Shaw has designed a piece intended to "bring the inside outside," a living room set complete with personal touches ("a coffee ring on the table, mementoes of family, pictures of loved ones, books that have been read") to be confined within the bounds of a parking space on 9th St. The piece entitled "Exposed to the Elements" will, in effect, accomplish just that, expose the living room to the elements presented not only by the weather, but also the curiosity of passersby who stop to take a look.

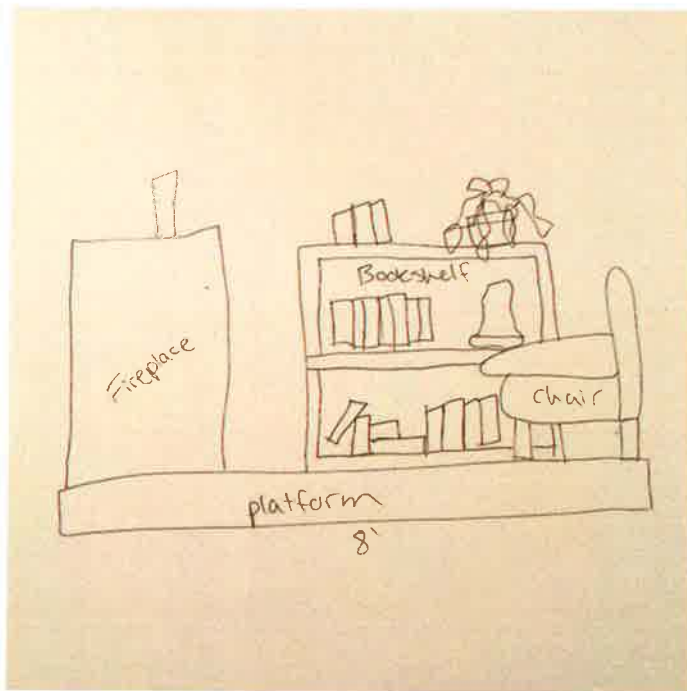

Elevation sketch of "Exposed to the Elements"

Construction

The piece will sit on a platform designed to fit within a single parking space made from painted plywood and 2x4s. The platform will be constructed in the manner of a framed floor, 2x4s turned on edge, plywood covering. Furniture will be selected and spaced on the platform to mimic a living room set. The piece will be anchored by a "fireplace" set at one end of the "living room." Other sourced furniture will include a bookshelf and a couch.

Installation timing

We plan to install the sculpture no earlier than Monday, February 27, 2017, and no later than Thursday, March 2. We will remove it on Monday, March 6, or, if weather is a concern, on Tuesday, March 7.

6. Pneuhaus inflatable interactive project

Pneuhaus (<http://www.pneu.haus/projects>) is an artist collective based out of Providence, RI. They create large-scale, immersive pieces that encourage interaction. With backgrounds in architecture, art, and design, they are very aware of the need to ensure that their pieces are structurally sound and safe for all participants, and we will work with them closely to ensure the safety of the piece and the install. They carry their own insurance.

We are in the process of determining whether or not it will be feasible for us to bring them to Columbia to create and install a new piece, which we would install in the street closure area discussed above (9th St block between Elm and Locust), and the piece would fit within the space of one and a half parking spaces, ideally in front of Columbia Art League. At this point, Pneuhaus are working on a design proposal based on a conversation with us about our needs/desires for the piece. It will be similar in feel and construction to their other pieces, which can be viewed on their website. We are not planning on the piece being tent-like in nature, but we do plan for the piece to be interactive, and with a molecular feel (see image of Pneumatic Masonry No. 3 below for visual reference).



Image of Pneumatic Masonry no.3, provided by artist collective, for visual reference.

7. Stacked cars with projection (“Empire Drive In Project”) on 9th between Elm & Locust

Description

NYC artist, Jeff Stark, will stack two cars in a parking space on 9th St. and use each car's windows as projection surfaces for short non-narrative films. In the words of the artist, past Empire Drive In films have addressed "public/private space, alternative forms of distribution, the anthropocene, recycle and reuse" among other topics.



Images from previous "Empire Drive In" installations. T/F's edition would collect the above ideas.

Construction

Short throw projectors will be situated within each car in such a way that the projectors throw images sized to the windows of the wrecked cars. Each car's projectors will be synced to screen the same film simultaneously. T/F will arrange for auxiliary power generated within or adjacent to the stacked vehicles. Cars will be stacked with a rough terrain forklift. As with past "Empire Drive In" projects, Jeff intends to have an engineer review the stability of the stacked cars upon completion of the installation.

City-related consideration: It's possible we'll need 1 or 2 select street lamps turned off near the installation on the East side of 9th St. We are also potentially interested in utilizing power from one of the street lamps for this project, if possible and available.

Installation

We plan to install the sculpture no earlier than Monday, February 27, 2017, and no later than Thursday, March 2. We will remove it on Monday, March 6, or, if weather is a concern, on Tuesday, March 7.

8. Wild Seed: Mobile Field Museum & Apothecary

St Louis based artist Emily Hemeyer is creating "Wild Seed", a trailer of curiosities, which will be touring the country during the summer of 2017; we will be premiering this piece at T/F 2017. The trailer itself is approximately 16' long (see photo below). Emily will be painting the exterior, and will create displays throughout the interior space. The displays will include items such as bottles, skulls, mushrooms, taxidermy, stones, minerals, and other natural items.

We plan to place the trailer, attached to a vehicle, in two parking spaces on 9th Street, on the east side of the

street. We will install the trailer on Thursday, March 2, and will remove it by noon on Monday, March 6.



Image of the trailer to be used by the artist.



Source images for plan for the displays inside the trailer (provided by artist).

9. Corner Playhouse sign

We will be installing one large sign at the Corner Playhouse in conjunction with MU. It is built from 1/2" plywood, schedule 40 - 4" diameter PVC, ripped 2x4s, star-drive exterior screws, weighting, and paint. A 4'x4' - 1/2" plywood square will anchor the sign. Four 8' tall ribs sit perpendicular to the plane of the base.

Notched PVC connects the tops and bottoms of the plywood ribs to ensure correct orientation. The bottom edge of each plywood rib is connected to the 4'x4' base via a ripped 2x4 that runs the length of that edge. The PVC coupling that caps the ribs is further notched in such a way that perpendicularly oriented plywood circles can be mounted atop the ribs. The whole structure will be weighted at the base and has been field tested for wind resilience at the True/False Lab and on the MU campus during the 2015 and 2016 festivals. Please see below for a photo of an installed sign on campus (NOTE: the sign at Corner Playhouse will be painted differently).



A similar sign as installed in 2015.

10. Parklet on 9th presented in Partnership with the Missouri Dept. of Conservation

In partnership with the Missouri Dept. of Conservation, True/False plans to arrange for a Parklet on 9th St. Emily Hemeyer, a St Louis-based artist who has presented work at past fests, will be supervising the creation and design of decoration for this piece. The DoC is providing the Fest a number of live trees that we intend to use, and Emily will be sourcing other recycled materials (such as downed branches) to fill out the space. The trees will come with wrapped root balls that we will obscure with some type of skirting. We expect to use between 4 and 6 trees depending on the trees the DoC is able to secure. We plan to consult with Parks and Rec for relevant logistical info and tailor design to relevant logistical considerations. We intend to have the Parklet set in front of Kaldi's adjacent to the bike racks on the Northwest corner of the 9th and Cherry intersection. As in 2016, we would like to install the parklet on the Friday prior to the fest, February 24, 2017.

11. 10th & Cherry City Parking Garage - Temporary Sign

As we have since 2013, we plan to install a large sign, pointing towards the Globe Theatre (the First Presbyterian Church on Hitt St.), on the 10th and Cherry City Parking Garage. The sign comprises 5

illuminated letters in a vertical stack, 10' tall and 2.5' wide, along with an additional circular segment containing an illuminated arrow, 2' in diameter.

As in prior years, for the 2017 fest we would like attach the sign to the north-east corner of the garage. The metal frame used has been reinforced with additional material and (4) attachment points, (2) each at the top and bottom of the frame. Cable riggings will be used to secure the top and bottom of the frame to the garage, by looping through attachment hooks and around the garage corner column and cinching the sign frame tightly against the column.

Add hook or bent tab to top corners
for attaching to hoist for lifting & lowering

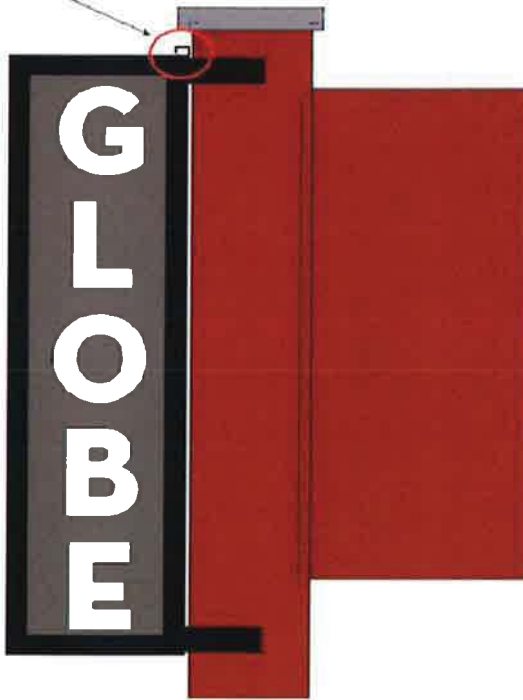

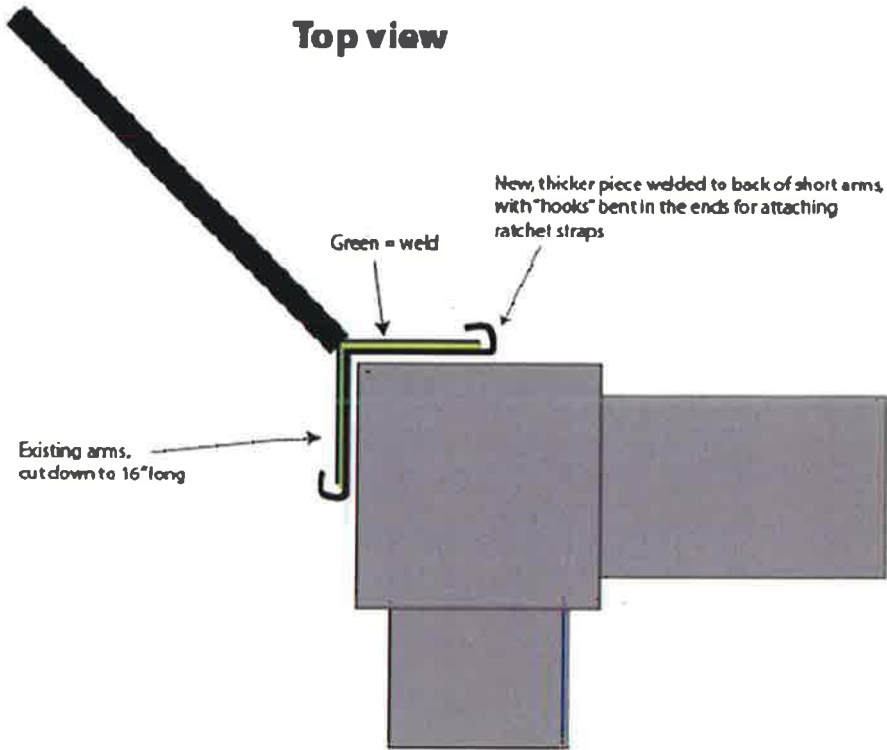

Images above show the hanging mechanisms.

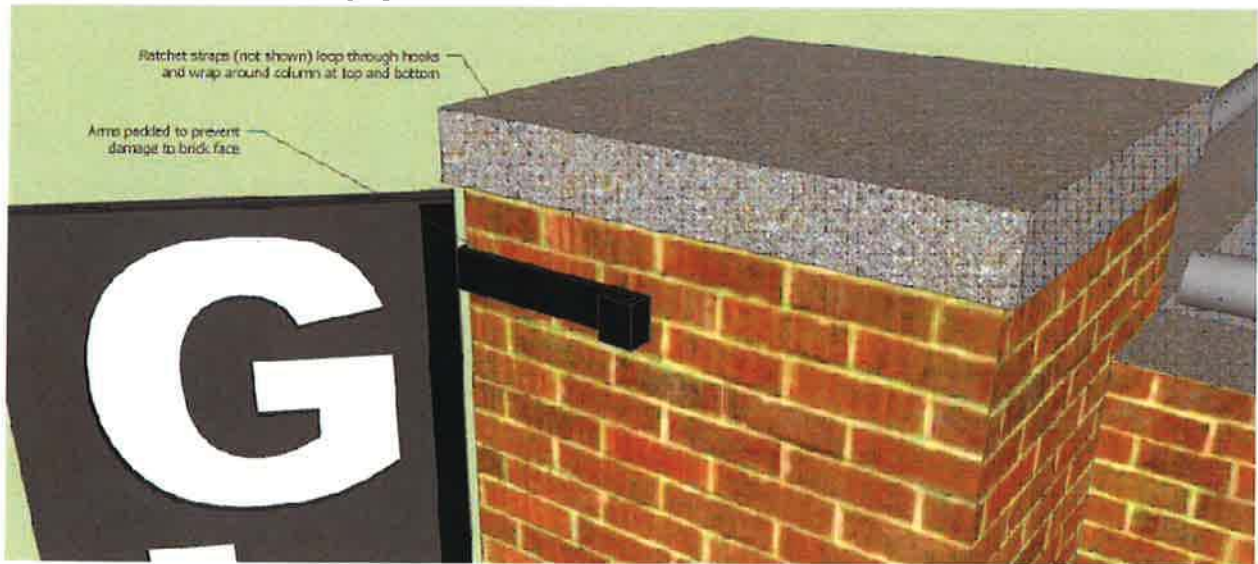

Images above show additional hanging mechanisms.

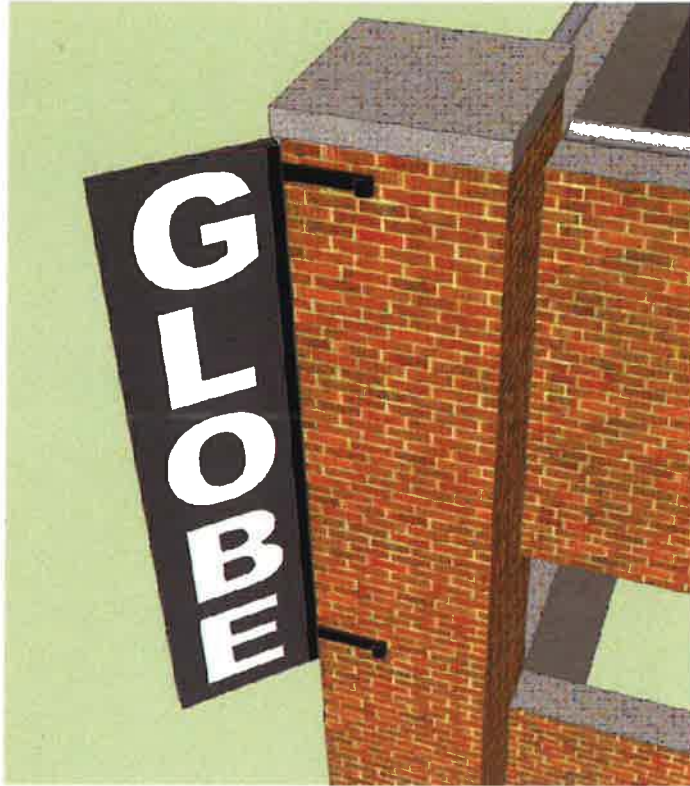

Artist rendition of installed sign.

We will also be using the available power source in the garage. We estimate that the total usage would be 110 volts, 60-80 watts, about like running a light bulb all weekend.

Installation is currently scheduled to be on Wednesday, March 1, 2017; we plan to take it down by the end of the day on Monday, March 6, 2017.

12. The Great Wall

As in the past three years, we will install a large-scale projection, which we call The Great Wall, onto an existing wall. As in previous years, we plan to project onto the exterior wall of the building in which the T/F offices are located (5 South 9th Street). The projector will be housed in the Copeland Law Firm building across the street. We are in the process of securing permission from the building and relevant business owners. The Great Wall is a carefully curated series of both short and feature length documentaries. It will run on Thursday, Friday, Saturday, and Sunday evenings during the fest (March 2 - 5, 2017) from 7-11pm. We would like to request that the City turn off the streetlight at the corner of 9th and Broadway during the planned presentation times.

Bus Shelters

In conjunction with students from the University of Missouri Architectural Studies Department, we are constructing 6 temporary bus shelters to be installed at various locations throughout the festival footprint. These shelters will serve as visual markers for those utilizing the CoMoConnect T/F bus route; additionally, they will be visually appealing, and will be works of art within their own right. What immediately follows are images of shelters that were constructed for the 2015 and 2016 festivals, which will be included among our six total for 2017.



Bus Shelters installed during T/F 2016

We have collaborated with Drew Brooks, Multi-Modal Manager (Transit + Airport) for the City of Columbia, to determine the best spots for these temporary structures.

Please see the attached documents for details on the approximate placements of these six structures, as well as student building plans for planned new 2017 shelter designs.

Supplemental Documentation Key

CoMOConnect-scheduledetails2017.pdf

TF_map2017.pdf

MU Bus Shelter - Team BusTigers.pdf

MU Bus Shelter - Team Vagabond.pdf

Bus schedule

Map of Fest Footprint (venues, art, bus shelters, etc.)

Bus Shelter Illustration

Bus Shelter Illustration

TRUE/FALSE film festival 2017 BUS ROUTES



True/False Loop
every 20 minutes
Thurs: 3pm-1:30am
Fri, Sat & Sun: 9am-1:30am

#10 Red/Downtown Loop
every 30 minutes
Thurs & Fri: 6:30am-8pm
Sat: 10am-8pm

LIVE BUS TRACKING & INFO at
www.COMOCONNECT.org
or on the COMOCONNECT APP.

