



**City of Columbia, Missouri
Unified Development Code**

February 2017

COLUMBIA UNIFIED DEVELOPMENT CODE
ARTICLE 4
FORM AND DEVELOPMENT CONTROLS

29-4.1 Dimensional Summary Table.

29-4.1(a) - General Dimensional Standards.

The following Tables 4.1-1 to 4.1-3 state the dimensional standards for residential, mixed use, and special purpose districts contained in Chapter 29-2 (Zoning Districts). In case of a conflict between the dimensions shown in this Section 4.1 and the dimensions shown for individual Districts in Chapter 29-2, the provisions of this Section 4.1 shall apply. In each table, a blank cell indicates that there is no standard for that dimension or measurement. (See Section Chapter 12 A of the City Code for additional required building setbacks from stream corridors. See Section 29-4.1(b)(2) (Solar Orientation Density Bonus) and Section 29-4.1(b)(3) (Rural Cluster Density Bonus), for additional information related to dimensional standard reductions and bonuses.)

Table 4.1-1: Dimensional Standards for Residential Districts					
Standard	District				
	R-1	R-2 [1]		R-MF [2]	R-MH
		Current	Cottage		
Lots					
Minimum Lot Area (sq. ft.)					
One-Family Dwelling	7,000	5,000	3,000	5,000	3,750
One-Family Attached Dwelling		3,500		3,500	
Two-Family Dwelling		7,000		7,000	
Multiple Family Dwelling				2,500 per du	
Sorority or Fraternity				7,500	
CRCC				No min, but max density 17du/ac	
Lot area if no public or community sewer [5]	15,000	15,000			
Minimum Lot Width (ft.) (detached)					
Minimum Lot Width (ft.) (detached)	60	60	30	60	45
Minimum Lot Width (ft.) (attached) – per lot					
Minimum Lot Width (ft.) (attached) – per lot		30		30	
Maximum size of contiguous area that may be replatted without being within a “cottage” subdivision					
Maximum size of contiguous area that may be replatted without being within a “cottage” subdivision			1		
Minimum Setbacks (ft.)					
Front Yard					
Front Yard Depth					
Front Yard Depth	25	25	10	25	20
Front lot line to garage depth (if applicable)					
Front lot line to garage depth (if applicable)	25	25	20		
Side Yard					
Side Yard					
Side Yard	6	6	6	10	10
Side Yard – Corner Lot Street Side					
Side Yard – Corner Lot Street Side	25	25	10	15	
Distance between mobile dwelling units					
Distance between mobile dwelling units					20
Rear Yard					
Rear Yard	Lesser of 30% lot depth or 25	Lesser of 25% lot depth or 25	10	25	10
Maximum Height (ft.)					
Primary Residential Building					
Primary Residential Building See also Sec 29-4.7 Neighborhood Protection Standards	35[3]	35[3]	35	35[3]	35
Primary Non-residential Building [4]					
Primary Non-residential Building [4] See also Sec 29-4.7 Neighborhood Protection Standards	75	75		75	

[1] All R-2 lands are subject to Current Standards until they request application of the Cottage Standards, and that request is approved under Sec. 29-6.4(i).

[2] Multifamily structures constructed before January 1, 2014, with building height up to 45 ft. and lot area of at least 1,500 sq. ft. per dwelling unit are conforming structures.

[3] Or 45 ft. if two side yards at least 15 ft. in width are provided.

[4] Provided that each building setback is increased one (1) foot above the District residential building minimum for each one (1) foot of additional building height above the residential building maximum.

[5] The minimum lot area for on-site septic is subject to Health Department approval based, in part, on distances between the lot and existing public sewer mains. This lot area could be greater, conditional, or denied on a case-by-case basis.

Standard	District						M-DT	
	M-OF	M-N [1]		M-C [2]		M-BP		
		Current	Pedestrian	Current	Transit			
Lots								
Minimum Lot Area (sq. ft.)							See Section 29-4.2 for M-DT Dimensional Standards	
Lot Area	0	0	0	0	0	0		
Lot Width at Building Line[3]	0	0	0	0	0	0		
Building Setbacks (ft.)								
Front Yard								
General	Min. 25	Min. 25	Min. 0 Max. 10 [4]	Min. 25	Min. 0 Max. 10 [4]	Min. 15		
From Arterial and Collector Streets	Min. 25	Min. 25	Min. 0 Max. 10 [4]	Min. 25	Min. 0 Max. 10 [4]	Min. 25		
Side Yard								
General	Min. 0	Min. 0	Min. 0	Min. 0	Min. 0	Min. 0		
Adjacent to R District	Min. 10	Min. 10	Min. 10	Min. 20	Min. 20	Min. 20		
Corner Lot with Frontage on Arterial or Collector Street	Min. 15	Min. 15	Min. 0	Min. 15	Min. 10	Min. 25		
Corner Lot with Frontage on Other Streets	Min. 15	Min. 15	Min. 0	Min. 15	Min. 10	Min. 20		
Rear Yard								
General	Min. 25	Min. 0	Min. 0	Min. 0	Min. 0	Min. 0		
Adjacent to R District		Min. 10	Min. 10	Min. 20	Min. 20	Min. 20		
Maximum Height (ft.)								
Primary Building See also Sec 29-4.7 Neighborhood Protection Standards	45	35	35	45	55	45		

[1] All M-N lands are subject to Current Standards until they request application of the Pedestrian Standards and that request is approved under Sec 29-6.4(i).

[2] All M-C lands are subject to Current Standards until they request application of the Transit Standards, and that request is approved under Sec. 29-6.4(i).

[3] If direct driveway access is proposed to lots fronting collector or arterial streets see Section 29-5.1(f)(1)(iv)(d)

[4] 75% of building frontage width must be located between minimum and maximum setback distances.

Standard	District		
	IG	A	O
Lots			
Minimum Lot Area (ac.)		2.5	2.5
Minimum Lot Area For Private Open Space (sq. ft.)			7,000
Minimum Lot Width at Building Line (ft.)		60	60
Minimum Setbacks (ft.)			
Front Yard	25	25	25
Side Yard – General	0	25	25
Side Yard – Adjacent to R District	20		
Rear Yard – General	10	25	25
Rear Yard – Adjacent to R District	20		
Maximum Height (ft.)			
Primary Building See also Sec 29-4.7 Neighborhood Protection Standards		35	35

29-4.1(b) - Special Dimensional Standards or Measurements.

- (1) Median Front Yard for Multiple Lots.
 - (i) In the R-1, R-2, and R-MF Districts, where the nearest lots on either side of a residential lot have been developed with residential structures, the median of the front yards of such residential buildings shall establish the minimum front yard depth for the subject lot. In no case shall the setback be less than the minimum setback established in Table 4.1-3 unless a reduction is approved by the Board.
 - (ii) Where a recorded plat has been filed showing a setback line that otherwise complies with the requirements of this Chapter, but is less than the established setback for the block as provided above, the setback line shown on the plat shall apply.
- (2) Solar Orientation Density Bonus.
 - (i) A subdivision in the R-1 or R-2 Districts in which at least seventy-five (75) percent of lots are created on blocks where the longer dimension of the block is oriented within fifteen (15) degrees of true east-west in order to increase potential solar gain, the maximum number of single-family or two-family lots permitted on the parcel under Table 4.3-1 shall be increased by ten (10) percent above the number of lots permitted, and the minimum size and width of each lot shall be reduced by fifteen (15) percent below the minimum lot size and width required if the streets had not been so aligned.
 - (ii) In a subdivision that meets the requirements for application of the Solar Orientation Density Bonus, the minimum lot size and lot width in the R-1 or R-2 Districts shall be adjusted to allow the parcel to contain ten (10) percent more lots greater than if the streets had not been so aligned.
- (3) Rural Cluster Density Bonus.
 - (i) A subdivision in the R-1 or R-2 Districts that preserves at least fifty (50) percent of the gross land area of the parcel in open space protected from future development shall be allowed to include ten (10) percent more residential lots than if such land had not been designated for protection.
 - (ii) In order to earn a density bonus, the lands protected from development shall meet the following requirements:
 - (A) The calculation of protected open space shall not include any lands designated as floodway or flood fringe in the FP-O Floodplain overlay;
 - (B) The protected lands shall include any lands designated as sensitive lands on the Land Analysis Map required by Section 29-5.1(b) to the greatest degree practicable;
 - (C) The protected lands shall be designed to be contiguous to any protected lands on adjacent subdivided lands to the greatest degree practicable;
 - (D) The applicant shall record in the real property records of Boone County a restrictive covenant, in a form acceptable to the City Counselor, or designee, preventing future development of the protected lands in perpetuity, and demonstrating that a homeowners association or other entity has accepted responsibility for maintenance and management of the protected lands and has legal authority to

collect funds from homeowners or others adequate to pay the expenses of such maintenance and management.

- (iii) In a clustered subdivision that meets the requirements for application of the Rural Cluster Density Bonus, the minimum lot size and lot width in the R-1 or R-2 Districts shall be adjusted to allow the parcel to contain ten (10) percent more lots greater than if fifty (50) percent of the gross land area had not been protected from development.
 - (iv) The Rural Cluster Density Bonus may not be combined with the Solar Access Density Bonus in Section 29-4.1(b)(2).
- (4) Rear Yards.
- (i) No rear yard shall be required in any nonresidential district on any lot of which the rear lot line adjoins a railway right-of-way or which has a rear railway track connection.
 - (ii) In computing the depth of a rear yard for any building where such yard abuts an alley, one-half of such alley may be assumed to be a portion of the rear yard.
 - (iii) The standards in Subsections (i) and (ii) do not apply in the M-DT District (Section 29-4.2), which has separate provisions for measuring building rear setbacks.

(5) Official Plan.

Where a line on the Major Roadway Plan (MRP) indicates that street widening has been planned and programmed for capital investment within five (5) years, right-of-way shall be reserved for future widening or opening of a street upon which a lot abuts, and the depth or width of a yard shall be measured from the MRP line to the nearest line of the building.

(6) Detached Accessory Structure.

- (i) In any residential district, a detached accessory structure shall not:
 - (A) Exceed twenty-four (24) feet in height;
 - (B) Be higher than the main building; or
 - (C) Occupy more than thirty (30) percent of a rear yard.
- (ii) A detached accessory structure may be connected with the main building by a breezeway, open on each side, not more than six (6) feet wide, the roof of which is not more than twelve (12) feet high at its highest point, and is not an extension of the roof of the main building.

(7) Higher Education Institution Buildings.

Buildings constructed on the campus of an institution of higher learning, and that have been included as part of a development plan approved by the Council, need not comply with the yard requirements of the district in which they are located, but shall comply with the following requirements:

- (i) Minimum distance between the building and a street line is twenty-five (25) feet; and
- (ii) Minimum distance to a property line other than a street is fifteen (15) feet for buildings thirty-five (35) feet or less in height, and five (5) additional feet for each additional ten (10) feet or part thereof in height.

29-4.1(c) - Exceptions and Encroachments.

(1) Height.

Table 4.1-4 identifies exceptions to those height limits shown in Section 4.1(a) and (b) above.

Table 4.1-4: Height Exceptions		
Structure, Feature, or Use	Maximum Height (ft.)	Conditions or Limits
Elementary/Secondary Schools in R-MF District	100	
<ul style="list-style-type: none"> ▪ Parapet walls ▪ False mansards ▪ Flagpoles ▪ Chimneys ▪ Finial cooling towers ▪ Elevator bulkheads ▪ Penthouses ▪ Stacks ▪ Cupolas ▪ Antennas ▪ Spires, and ▪ Rooftop solar energy equipment ▪ Rooftop HVAC equipment screened by parapet wall 	6 feet above maximum height limit of District	
Rooftop or yard mounted WECs equipment in M-BP or IG District	30 ft. above maximum height limit in District	
Agricultural uses (e.g. silos, windmills, barns, etc.) in A-1	75 feet	
Radio and television antenna (private, noncommercial) in Residential districts	45 feet	Must not be located in front yard, and must comply with all other applicable laws and ordinances.

(2) Yard Areas

Table 4.1-5 identifies exceptions and encroachments to required yard areas. Except for permitted exceptions in the table, every part of a required yard or court shall be open and unobstructed from its lowest point to the sky.

Table 4.1-5: Yard Area Exceptions				
Structure, Feature, or Use		Yard Encroachment (maximum)		Conditions or Limits
Building sills, belt courses, cornices, chimneys, buttresses, ornamental features, eaves, and rain barrels		2 ft. into a yard		
Canopies or open porches		6 feet into front or rear yard		Roof area limited to 60 sf or less; Porch cannot be enclosed
Driveways	Single- and Two-Family Residential	Up to a 2-car garage	Permitted to a maximum width of 20 ft. in any front, rear, side, or corner side yard	Single- and two-family residential driveways shall maintain a setback of 5 ft. from the side property line and shall not occupy more than 50% of the lot width.
		3-car garage	Permitted to a maximum width of 28 ft. in any front, rear, side, or corner side yard	
		Shared duplex driveway	Permitted to a maximum width of 36 ft. in any front, rear, side, or corner side yard	
	Multi-Family, Commercial, and Mixed-Use	Permitted to a maximum width of 24 ft. (one-way, in or out), and 36 ft. (combined, in and out) in any front, rear, side, or corner side yard	Multi-family, commercial, and mixed-use driveways shall maintain a setback of 10 ft. from any side property line adjacent to a Residential district, or as determined by the required driveway radius.	
Lot boundary fences, walls, and retaining walls		Permitted up to lot line		May not encroach on public right-of-way or adjacent property without consent of owner
Open fire escape		Into side yard, by no more than ½ the side yard width		Cannot extend more than 4 feet from the building
Open paved terraces		10 feet into front or rear yard		
Solar or geothermal energy equipment		Permitted in a side or rear yard		Not within 2 feet of a side or rear property line

29-4.2 M – DT Form-based Controls.

The M-DT District is to encourage a mixed-use, pedestrian-oriented district - with a secondary focus on land uses. Property frontages and Façades are part of the public realm, literally forming the walls of the Street-Space and are therefore subject to more regulation than the other portions of the private property.. The principal regulatory sections of the M-DT District are the Regulating Plan, the Building Form Standards, and the Urban Space Standards, described below.

29-4.2(a) - Purpose and Intent

(1) The Regulating Plan.

The Regulating Plan applies M-DT regulations to individual properties in the District. It is public space master plan with specific information on development parameters for each parcel and shows how each lot relates to the Street-Space and the surrounding neighborhood. The Regulating Plan also identifies additional regulations and/or opportunities for lots in specific locations, as well as place-specific exceptions to the Building Form Standards.

(2) The Building Form Standards.

The Building Form Standards (BFS) are coded street frontages. They establish basic parameters governing building form for different locations shown on the Regulating Plan in order to shape the Street-Space through the site and form controls on buildings. Their secondary intent is to ensure that the buildings are coordinated to form a functioning, sustainable, Block structure throughout the District. They describe the buildable envelope (in three dimensions) and certain permitted or required building elements that define the form and mixed-use character of the District. The Building Form Standards establish both the boundaries within which things may be done and specific things that must be done. The street frontage designated on the Regulating Plan determines the applicable Building Form Standard for a building site.

(3) The Urban Space Standards.

The Urban Space Standards establish those rules and standards for the Street-Space and Squares and Greens within the M-DT District that are the responsibility of the developer. They establish an environment that encourages and facilitates pedestrian activity and “walkable” streets that are comfortable, efficient, safe, and interesting, and ensure the coherence of the Street-Space.

29-4.2(b) - Using the M-DT District Form Standards.

This section describes how to apply the requirements of the M-DT District to specific properties.

- (1) Look at the Zoning map and determine if property in question is located within the M-DT District. If it is not, then Section 29-4.2 is not applicable.
- (2) Look at the Regulating Plan in Section 29-4.2(c) and find the property in question. Note the color of the Street-Space fronting the lot—and then look at the “key” box to determine

which Building Form Standard frontage applies to the property. Note the Required Building Line and the Parking Setback Line.

- (3) Find the applicable individual Building Form Standard in Section 29-4.2(e). The individual Building Form Standard frontage will tell you the parameters for development on the lot in terms of height, siting, elements, and use.
- (4) Additional regulations applicable to all properties in the M-DT District are located in Sections 29-4.2(d)(General Building Form Standards) and (f)(Urban Space Standards).

Land uses, parking requirements, and signage standards that apply to the M-DT District are found in Article 3 and in Sections 29-4.3 and 29-4.8 of this Chapter.

29-4.2(c) - The Regulating Plan.

The Regulating Plan makes the M-DT standards place-specific, by describing where each Building Form Standard applies and by defining the public spaces. The Regulating Plan also identifies the items below, as illustrated in the Plan and Key that follow:

- The boundaries for the district;
 - Existing and proposed streets and Alleys;
 - The Required Building Lines, Parking Setback Lines, and Lot Building Limits.
- (1) Understanding the Regulating Plan.

The following images of the M-DT District Regulating Plan and Key are for illustrative purposes only. Contact The Community Development Department for further information about the M-DT District and shall maintain a copy of the Regulating Plan with the Official Zoning Map.

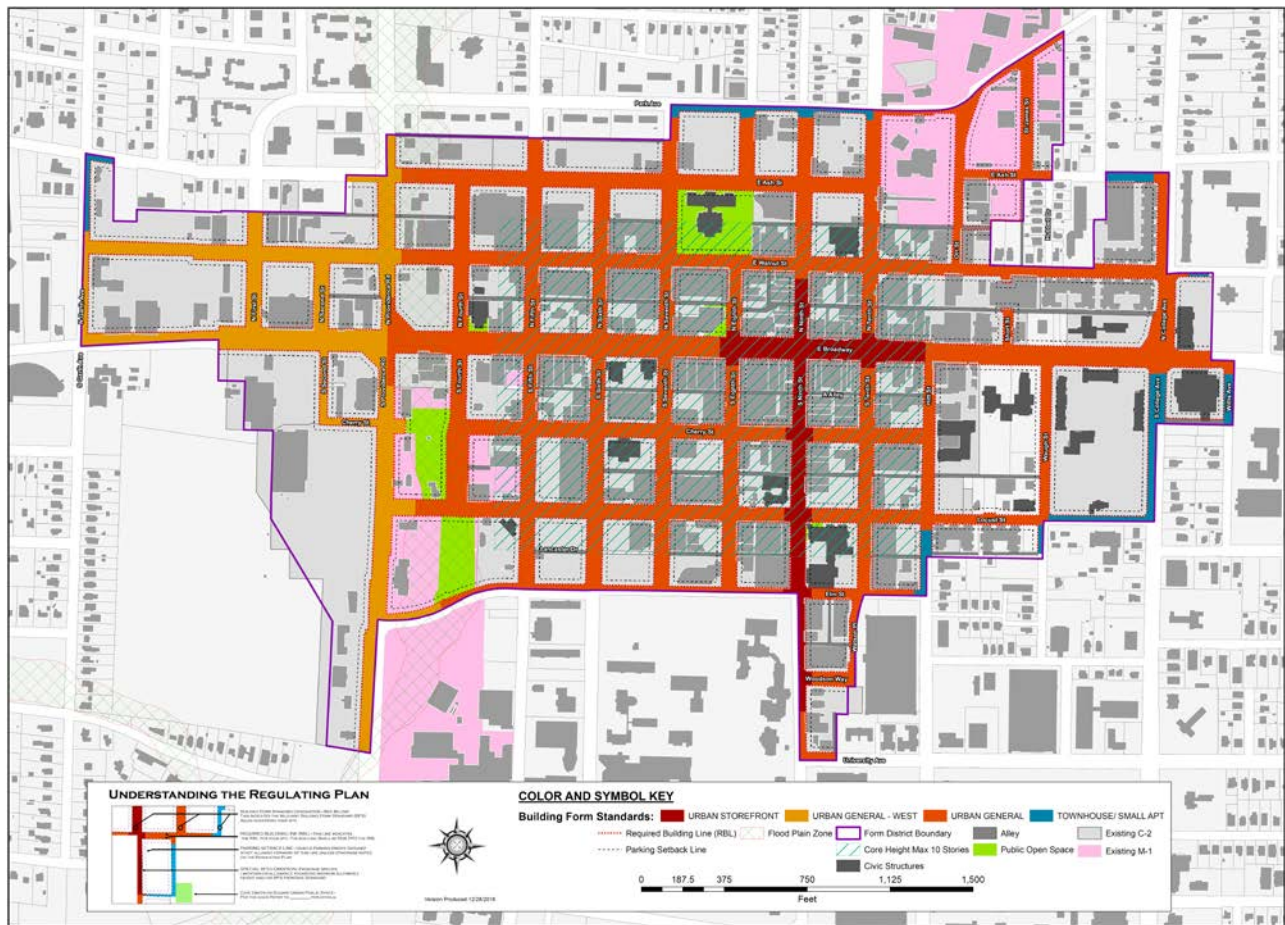

The Regulating Plan Key, below, highlights the regulations conveyed on the Plan.

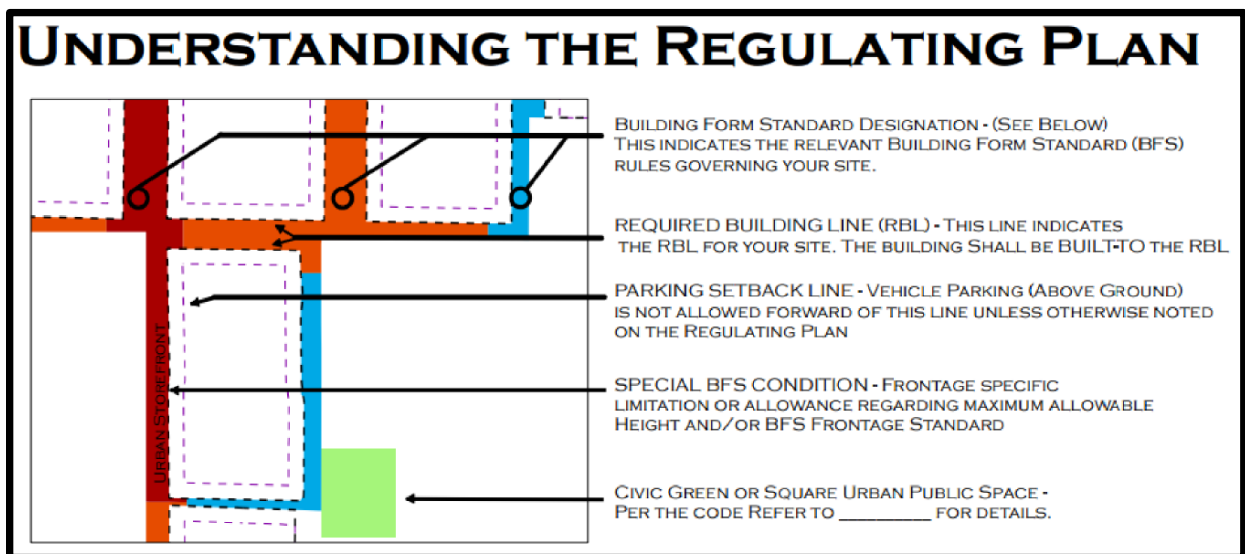

- (2) Streets, Blocks and Alleys on the Regulating Plan.
- (i) Street connectivity and the pedestrian-oriented public realm are fundamental characteristics of the M-DT District. When a property is developed or redeveloped:
 - (A) For large-scale projects, that involve a site that is the majority of a block or more, applicants shall apply for an amendment to the Regulating Plan which may require the addition of new streets or alleys to create a smaller block pattern.
 - (B) No streets or alleys shown on the Regulating Plan may be removed without a replacement street being constructed in a location that maintains overall street connectivity in that area.
 - (C) New Alleys or Pedestrian Pathways required by the Regulating Plan or a Regulating Plan amendment shall be public, or publicly accessible.
 - (D) All lots shall share a frontage line with a public street.
 - (ii) Block size is a key component of walkability. For existing Block Faces of greater than three hundred fifty (350) feet in length at the time of redevelopment:
 - (A) The Block Face must be interrupted by an Alley, Common Drive, or Pedestrian Pathway providing through-access to another public street, alley, common drive or designated conservation Line.
 - (B) Individual lots or development sites with up to one hundred fifty (150) feet of street frontage are exempt from the requirement to interrupt the Block Face.
 - (C) Individual lots or development sites with more than one hundred fifty (150) feet of street frontage shall meet the requirement within the lot or site, unless already satisfied within that Block Face.
 - (iii) Curb Cuts interfere with pedestrian movement and should be limited or removed to the extent possible during redevelopment.
 - (A) For lots with an Alley accessible to service vehicles, existing curb cuts shall be eliminated or vacated at the time of redevelopment unless the Director in consultation with the Department of Public Works determines that they are necessary to protect public safety or avoid traffic congestion, or because Alley access will not serve the functional needs of the property.
 - (B) For lots without Alley access, existing curb cuts may be maintained or relocated along the same frontage.
 - (C) Where a parking structure is provided with at least thirty (30) percent of its spaces publically available, existing curb cuts may be relocated or maintained to provide access to the structure, even if the parcel has Alley access.
 - (iv) Alleys are a key component of M-DT District connectivity and service infrastructure.
 - (A) Alleys or Common Drives must provide automobile and service access to the rear of all lots, except where the City has regulated alley access, where lots abut non-developable lots, or where a lot has streets on three sides and the absence of an Alley or Common Drive would not deprive an adjacent neighbor of rear lot access.
 - (B) New Alleys require an amendment to the Regulating Plan.

- (C) For new Alleys or Common Drives, public access, public utility, and drainage shall be dedicated through an irrevocable easement.
 - (D) Alleys may be incorporated into (rear) parking lots as standard drive aisles if cross-access to all abutting properties is maintained.
 - (E) Where an Alley does not exist but is identified on the Regulating Plan, and it is not feasible to construct the Alley at the time of redevelopment, no permanent structure shall be constructed on the proposed Alley right-of-way.
- (3) Regulating Plan Amendments.

Any amendment or change to the Regulating Plan shall require the adoption of a revised Regulating Plan through the same procedures used for an amendment to the Zoning Map as described in Chapter 6 (Procedures and Enforcement) of this Code.

29-4.2(d) - General Building Form Standards.

The Building Forms detailed in this section establish the standards and parameters for new development and redevelopment within the M-DT District. The following standards apply to all Building Form Standard frontages, unless expressly stated otherwise within an individual Building Form Standard or otherwise designated on the Regulating Plan.

(1) Transitions.

When the Building Form Standard designation shown on the Regulating Plan changes along a property's Required Building Line, that property owner has the option of applying either Building Form Standard for a maximum additional distance of up to eighty (80) feet along that Required Building Line, as measured from the lot corner nearest the transition.

(2) Façade Composition.

"Façade composition" is the arrangement and proportion of Façade materials and elements (windows, doors, columns, pilasters, bays). Complete and discrete" means one part of the Façade is different from another to break down the perceived scale of large buildings and provide a better pedestrian experience.

- (i) The maximum length of individual façade compositions along a Required Building Line, generally running parallel to the fronting sidewalk, for each Building Form Standard is specified in the Elements section of the Individual Building Form Standard Frontage standards.
- (ii) New buildings and new building Façades are required to achieve a Complete and Discrete Vertical Façade Composition along a street frontage. This requires -compliance with the following minimum standards:
 - (A) There must be a clearly different Ground Story Façade configuration, either materials or Fenestration proportions and spacing or both, from one Vertical Façade Composition to the next; and at least two of the following:
 - (B) Fenestration proportions differing between one Vertical Façade Composition to the next of at least twenty (20) percent in height or width or height:width ratio (See Figure 4.2-1).

- (C) At least two (2) different bay configurations (See Figure 4.2-2).
- (D) Change in wall material (changes in paint color are insufficient).
- (E) Change in total Fenestration percentage (minimum difference ten (10) percent; ground floor Façades are not included).
- (iii) Each Façade composition, regardless of the number of bays such composition may have, shall include a functioning street entry door.
- (iv) Individual infill projects on lots with street frontage of less than one hundred (100) feet on a Block Face are exempted from the overall Façade composition requirement for that Block Face, but shall still include a functioning street entry.
- (v) Where glass is used to meet the fenestration requirements, it shall have a light transmission at the Ground Story of at least seventy (70) percent and for the upper stories at least fifty-five (55) percent, unless otherwise required by the building or energy conservation code.

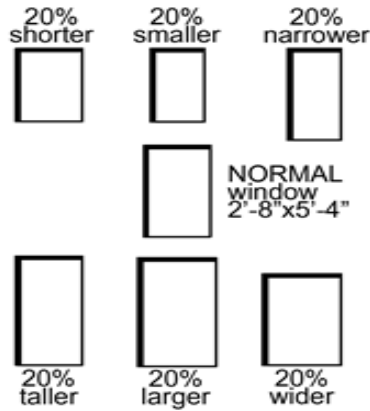

Figure 4.2-1: Fenestration Proportions: Minimum differences to achieve subsection (B)

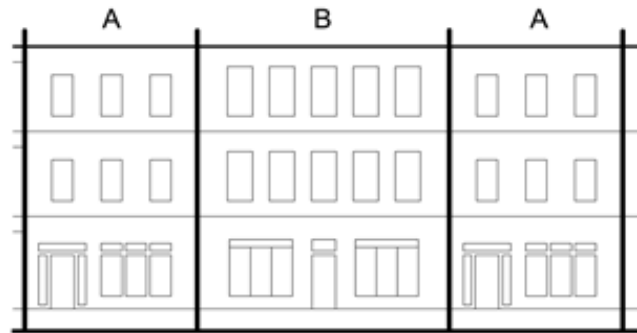

Figure 4.2-2: Different Vertical Façade Bay Compositions within a Block Face- “A” and “B” have: different number of bays; different Ground Story window and door configurations; and different Upper Story window sizes and spacing.

(3) Building Size.

The maximum ground floor footprint for each building, but not including parking structures that comply with this Code, is thirty-four thousand (34,000) gross square feet. The construction of larger buildings shall require an Adjustment of Form-based Controls as described in Section 29-6.4(e).

(4) Neighborhood Transitions.

For any Urban General, Urban Storefront, and Urban General-West frontage sites, the following rules apply.

- (i) Where a site shares a Common Lot Line with a lot in any zoning classification that is actually used for single-family dwelling purposes or that is limited to a single-family detached residential dwelling use due to lot size (area and width):

- (A) There shall be at least a twenty (20) foot setback from the Common Lot Line. Common Drives and Alleys are allowed in this setback area. (See Figure 4.2-3).
- (B) Notwithstanding any minimum height requirement, within fifty (50) feet of the Common Lot Line, and within eighty (80) feet of any Required Building Line, the structure shall have a maximum height of thirty (30) feet. (See Figure 4.2-4).

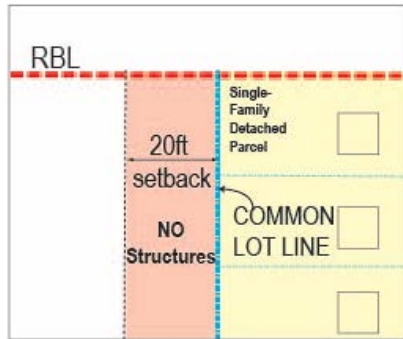

Figure 4.2-3: Common Lot Line Setback

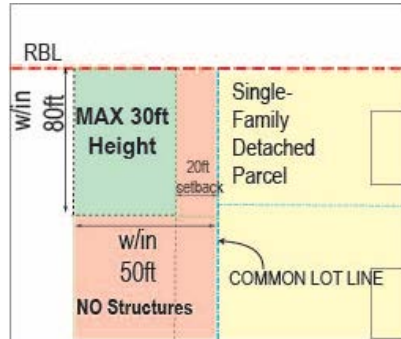

Figure 4.2-4: Common Lot Line & Height

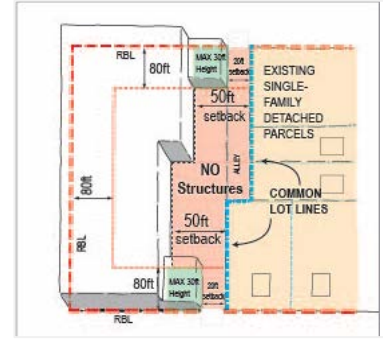

Figure 4.2-5: Buildable Envelope Limitations (Illustrative Intent)

- (C) Farther than eighty (80) feet from any Required Building Line, there shall be an additional thirty (30) foot setback -- for a total setback of fifty (50) feet -- from the Common Lot Line for all structures. Surface parking and Common Drives and Alleys are allowed in this setback area. (See Figure 4.2-4).
 - (ii) Where a site shares a Common Lot Line with (or sits across an Alley from) a single-family residential property, a garden wall, four (4) to six (6) feet in height, shall be constructed within one (1) foot of the Common Lot Line or Alley. Trees from the Street Tree List shall be planted, on maximum thirty (30) foot centers, within ten (10) feet of this wall. Required tree planting numbers and locations may be adjusted to accommodate any required fire access.
- (5) Height.
- (i) The height of all buildings is measured in Stories, with a Building Height limit in feet, measured from the average fronting sidewalk elevation to the top of the wall plate, unless otherwise designated in this Section 29-4.2.
 - (ii) The minimum Façade height that is required at the Required Building Line is shown on the individual Building Form Standard.
 - (iii) English basement units do not count against the building story height limit but do count against the Building Height measurement.
 - (iv) If a parking structure is constructed after the adoption of this Section 29-4.2 and any portion of the parking structure is located within thirty (30) feet of a building constructed pursuant to this Section 29-4.2, no portion of the parking structure shall exceed the building's primary roof ridge or parapet height.
 - (v) At least eighty (80) percent of each Story must meet the minimum Clear Height prescribed in the Individual Building Form Standard.

- (vi) The Ground Story finished floor elevation requirements shall be measured:
 - (A) From the average exterior sidewalk elevation at the Required Building Line, and
 - (B) Within thirty (30) feet of any Required Building Line.
- (6) Siting.
 - (i) Building Façades shall be built to the Required Building Line as stated in the Individual Building Form Standard.
 - (ii) The building Façade shall be built to the Required Building Line within thirty (30) feet of a Block Corner, unless otherwise stated in the Individual Building Form Standards.
 - (iii) The Required Building Line, which is shown on the Regulating Plan as an absolute line, allows an offset area (or depth) of twenty-four (24) inches beyond that line (into the Buildable Area) to allow for Façade articulation, unless otherwise stated in this Section 29-4.2. Portions of the Façade located within that twenty-four (24) inch zone comply with the Required Building Line.
 - (A) The Required Building Line for property located along Providence Road, regardless of Frontage Type, allows an offset area (or depth) of sixty (60) inches beyond that line (into the Buildable Area) to allow for Façade articulation. Portions of the Façade located within that sixty (60) inch zone comply with the Required Building Line. If no building is located within this area, it shall be improved with landscaping materials as approved by the City Arborist.
 - (iv) Buildings may only occupy that portion of the lot specified as the Buildable Area—the area behind the Required Building Line as designated by the individual Building Form Standards.
 - (v) No part of any building may be located outside of the Buildable Area except overhanging eaves, awnings, stoops, steps, or balconies. Handicapped ramps approved by the Director in order to comply with federal law may also extend beyond the Buildable Area. Stoops, steps, and ramps shall not be located within a required Clear Walkway. For appropriate commerce and retail uses, temporary displays or cafe seating may be placed in the Dooryard.
 - (vi) No part of any building may be located outside of any designated Lot Building Limit.
 - (vii) There is no required setback from Alleys or Common Drives except as stated on the Building Form Standards. On lots without Alley access, a minimum twelve (12) foot setback from the rear lot line shall apply.
 - (viii) There are no side lot setbacks, except as specified in the Neighborhood Transitions (above) or in the Building Form Standards.
 - (ix) The Parking Setback Line is generally twenty-four (24) feet behind the Required Building Line and extends as a vertical plane from the first floor level unless otherwise shown on the Regulating Plan or otherwise stated in this Section 29-4.2. Vehicle parking shall be located behind the Parking Setback Line, except where parking is provided below grade, on-street, or otherwise indicated on the Regulating Plan.

- (A) Except for buildings located along Ninth Street and Broadway, the Parking Setback Line on second floor levels and above may extend to the Required Building Line of the frontage type as shown on the Regulating Plan.
 - (B) Parking shall not be located closer than six (6) feet to the Required Building Line on any first floor level, with the following exceptions: a) If a public utility easement is located within the parking setback, preventing its use for building purposes, parking may be included in the easement area; b) A parking area of not greater than sixty (60) feet in width located to the side of a building may be permitted if the parking area is screened from the street by a street wall and no new curb cut is made in the public street.
 - (x) All lots, including corner lots and through lots, shall satisfy the build-to requirements for all of their Required Building Line frontages, and the Dooryard and/or front yard requirements for each designated Building Form Standard, unless otherwise stated in this Section 29-4.2.
 - (xi) Where a Street Wall is permitted or required in the individual Building Form Standard, it shall be a minimum of four (4) feet and a maximum of eight (8) feet in height. When required to screen the edge of a parking area or outdoor refuse or bulk material storage area, the street wall shall be located along any Required Building Line frontage that is not otherwise occupied by a building.
 - (xii) Street walls may be constructed utilizing either masonry, ornamental materials, or a private landscape buffer in accordance with the provision of Section 29-4.4(d)(i), or any combination thereof. Walls may be opaque or partially open and may include landscaping.
- (7) Private or Public Open Area.

Private or public open area must comply with standards in each Individual Building Form Standard Frontage (Section 29-4.2(e)) and in Section 29-4.4 (Landscaping and Screening).

- (i) Non-residential Open Space Requirements. Private or public open area shall be provided for lots greater than 10,000 square feet in buildable area, according to the following schedule:
 - (A) Ten (10) percent of the total buildable area shall be allocated as open area.
 - (B) In addition to item (i), above, buildings that contain four (4) or more dwelling units shall provide private or public open area as prescribed Item (2), below.
 - (C) Thirty-three (33) percent of required public or private open area may be satisfied through the use of balconies of individual units meeting the requirement of item (v), below, or rooftops.
 - (D) Retail sales that have sales floors for customers and commercial services that provide customer seating or gathering areas, such as restaurants, lodging, and entertainment uses, shall not be subject to the minimum open area requirement.
 - (E) Private or public open area may be located on any floor or combination of floors or any location on the lot provided it is accessible to all residents or tenants of the building the open area requirement is intended to benefit.

- (F) Any single private or public open area, with the exception of individual balconies, shall be a minimum of seventy (70) square feet and shall have a minimum dimension of seven (7) feet and a minimum contiguous area of 70 square feet.
 - (G) Balconies may be counted as “private open area” when their minimum size is 8-feet wide and 5-feet deep.
- (ii) Residential Open Space Requirements. Private or public open area shall be provided in any building which contains four or more dwelling units, according to the following schedule:
- (A) 70 square feet per dwelling unit (efficiency; 1-2 bedrooms); 100 square feet per dwelling unit (3 or more bedrooms).
 - (B) Private or public open area may be located on any floor or combination of floors or any location on the lot provided it is accessible to all residents or tenants of the building the open area requirement is intended to benefit.
 - (C) Any single private or public open area, with the exception of individual balconies, shall be a minimum of seventy (70) square feet and shall have a minimum dimension of seven (7) feet and a minimum contiguous area of 70 square feet.
 - (D) Balconies may be counted as “private open area” when their minimum size is 8-feet wide and 5-feet deep.
- (8) Balconies.
- (i) Balconies may not project within five (5) feet of a Common Lot Line.
 - (ii) Balconies shall not project more than 2 feet forward of the required building line (RBL).
 - (iii) Where an Individual Building Form Standard includes Balconies as a method for achieving the required Private or Public Open Area, the Balcony:
 - (A) Shall be enclosed by balustrades, railings, or other means;
 - (B) Shall not otherwise be enclosed above a height of forty-two (42) inches, except with insect screening and/or columns/posts supporting a roof or connecting with another Balcony above; and
 - (C) Shall be covered, by roofs or by balconies above.
 - (iv) Balconies on new, renovated, or retrofitted construction may project into the public right-of-way only if:
 - (A) The improvement complies with Section 24-2(c) of the City Code;
 - (B) The balcony projects only over a public sidewalk or an alley, provided that such projection does not cause a disruption to any City service or maintenance of the underlying public improvements. No balcony shall project over the travel lanes of any public street; and
 - (C) The proposed balcony meets all applicable design standards contained in this Code and other ordinances passed by the Council.
- (9) Other Building Elements.

- (i) Fenestration is regulated as a percentage of the Façade between floor levels. It is measured as glass area (including mullions and similar window frame elements with a dimension less than one inch) or as open area.
- (ii) As illustrated in Figure 4.2-6, unless otherwise designated in the individual Building Form Standards or in the Building Code, no window within ten (10) feet of a Common Lot Line may be at an angle of less than ninety (90) degrees from that Common Lot Line unless:
 - (A) That view is contained within the lot (e.g. by a privacy fence/garden wall, opaque glass), or
 - (B) The sill (or other limit to transparency) is at least 6 feet above its finished floor level.
- (iii) No part of any building may project forward of the Required Building Line except overhanging eaves, awnings, stoops, steps, or balconies. Handicapped ramps approved by the Director in order to comply with federal law may also extend beyond the Buildable Area.
- (iv) Ground Story awnings shall maintain a minimum horizontal clearance of one (1) foot from any point where the tree lawn meets the Clear Walkway.
- (v) Bay Windows shall have an interior clear width of between four (4) and eight (8) feet at the Façade. Bay Windows shall project no more than forty-two (42) inches beyond the Façade.

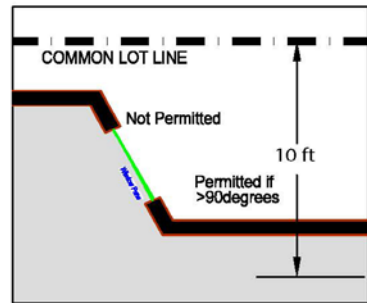
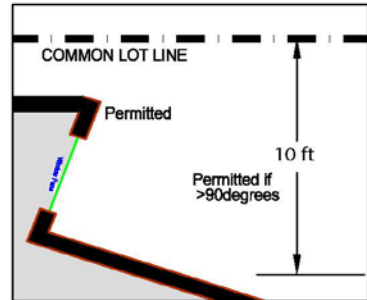
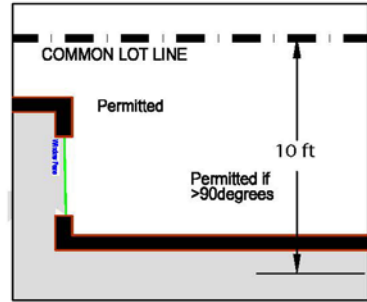

Figure 4.2-6: Relationship between a window and Common Lot Line.

- (vi) Attic Stories are permitted within all Building Form Standard frontages.
 - (A) On the Required Building Line/ Façade side of the roof pitch, Attic Story windows may only be located in dormers and/or gable ends.
 - (B) Attic Story Dormers are permitted so long as they do not break the primary eave line, are individually less than fifteen (15) feet wide, and their collective width is not more than sixty (60) percent of the Required Building Line Façade length.
 - (C) The floor area of an Attic Story, measured as the floor area with a building code minimum Clear Height, may not occupy an area greater than seventy-five (75) percent of the floor area of the Story immediately below.
 - (D) Attic Stories meeting the above standards do not count against the maximum Building Height in feet or Stories.

- (vii) Where visible from the Street-Space, pitched roofs, exclusive of roofs behind parapet walls, shall be pitched between 4:12 and 12:12. Shed roofs, attached to the main structure, shall be pitched between 3:12 and 8:12.
 - (viii) English Basement Accessory Dwelling Units are permitted in Townhouse frontages and do not count against the maximum building height in Stories provided they have windows above grade and have direct street frontage access.
 - (ix) At least one functioning entry door shall be provided along each Ground Story Façade. No Ground Story Façade may include a section of greater than seventy-five (75) feet without a functioning entry door, unless otherwise stated in the Building Form Standards.
 - (x) All required Front Porches shall be completely covered by a roof. Front Porches may be screened when all architectural elements (columns, railings, etc.) occur on the outside of the screen on the side facing the Street-Space. The Front Porch finished floor height shall be no more than eight (8) inches below the first interior finished floor level of the building to which it is attached. Front Porches shall not extend past the Dooryard into the Clear Walkway.
 - (xi) The Stoop finished floor height shall be no more than eight (8) inches below the first interior finished floor level of the building to which it is attached. Stoops shall not extend past the Dooryard into the Clear Walkway.
 - (xii) Privacy Fences may be constructed along Alleys and along Common Lot Lines, but shall not be constructed forward of the Required Building Line. Privacy Fences shall have a maximum height of eight (8) feet.
- (10) Building Functions.

Broad parameters for allowable uses for Ground Stories and upper Stories are identified in each Building Form Standard. Specific permitted use standards are provided in Chapter 29-3.

(11) Civic Buildings.

When Civic Buildings are designated on the Regulating Plan, they are exempt from the Building Form Standards. Additions to civic buildings shall require amendment of the Regulating Plan.

(12) Gas Station or Fueling Center with a Convenience Store.

A gas station or fueling center with a convenience store shall be a permitted use within the Urban General West frontage type, as shown on the Regulating Plan, and shall not be subject to the required building line setback as defined for other uses within said frontage type.

(13) Solid Waste Management.

All new buildings and/or change in use shall have a plan for the management - collection, storage, and disposal - of solid waste. The City, based on the anticipated volume of solid waste and frequency of collection, may require trash rooms or trash enclosures within

buildings or lots to facilitate orderly pick-up of solid waste and avoid congestion and accumulation of waste and waste receptacles within alleys and other public ways.

29-4.2(e) - Individual M-DT Building Form Standard Frontages.

This Section describes the intent and the standards applicable to each Individual Building Frontage Type designated on the Regulating Plan. The three Individual Building Frontage Types are:

- Urban General/Urban Storefront
- Urban General – West
- Townhouse/Small Apartment

Photos are provided to illustrate each frontage type and are advisory only. Where the statements of intent or photographs are inconsistent with the standards, the standards shall apply.

(1) Urban General/Urban Storefront Frontage.

(i) Illustrations and Intent.

Urban General is to be used for those properties fronting the orange Street-Spaces on the Regulating Plan.

Urban Storefront is to be used for those properties fronting on the red colored Street-Spaces on the Regulating Plan.

Urban General is the basic urban street frontage, once common across the United States. The purpose of this frontage is to develop multi-story buildings placed directly at the sidewalk with one or more entrances and windows across the Façade. The uses range from commercial to residential, municipal to retail and restaurants— and combinations of all of the above. There could be several buildings lined up shoulder to shoulder, filling out a Block, or on smaller Blocks, a single building might fill the Block Face.



Small mixed-use buildings with individual Shopfronts.



Large mixed-use buildings with Shopfronts and vertical Façade composition to provide pedestrian scale



Street-oriented residential buildings with small Dooryards.

Where Urban Storefront is designated on the Regulating Plan, the Urban General Building Form Standard shall apply, and the additional specific standards for Urban Storefronts set forth in this subsection shall also apply. The main distinction between Urban General and Urban Storefront is that the Urban Store Ground Story configuration shall be that of a Shopfront – with uses limited to retail, food and beverage, or personal service.

The Urban Storefront frontages are designated in the most intense areas of the M-DT District and it is anticipated that there will be significant pedestrian traffic along these Blocks. The photos illustrate the range of buildings that could be constructed under the Urban General and Urban Storefront frontages.



Transparent Ground Story Façades provide views between interior and exterior, enlivening the sidewalk.

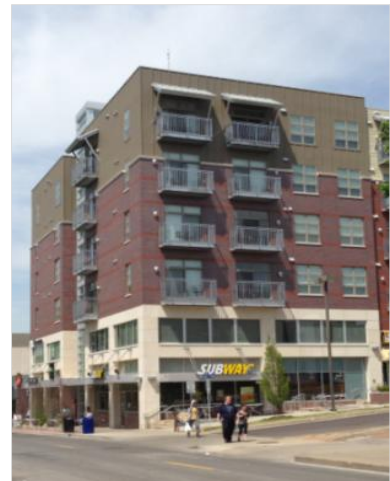

Shopfronts line the Ground Story, with offices or residences above.

(ii) Height.

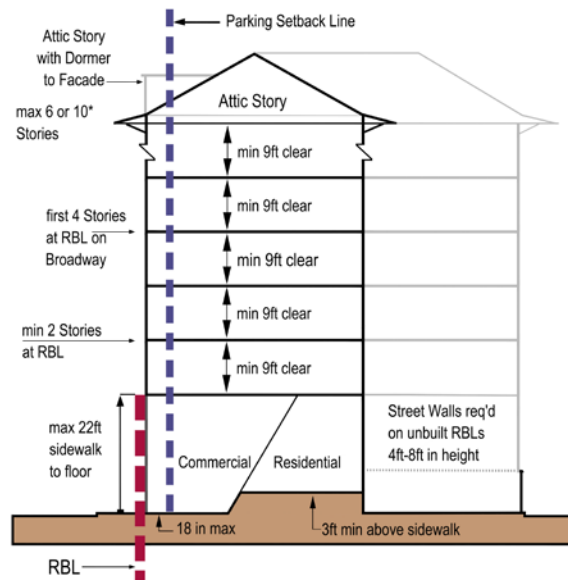

Figure 4.2-7 Urban General/Urban Storefront Height Standards

(A) Building Height.

- 1) The building shall be at least two (2) Stories (the second story shall be occupiable and meet the definition of a story) in height at the Required Building Line, but no greater than six (6) or ten (10) stories, *as designated on the Regulating Plan, with an Building Height of seventy-two (72) or one hundred forty-two (142) feet respectively. For buildings on Broadway that are four (4) or more Stories, the first four (4) Stories shall be built to the Required Building Line.
- 2) Proposed buildings may be permitted to exceed the maximum height for their location as shown on the Regulating Plan subject to following the provisions of Section 29-6.4(p) (Tall Structures in the M-DT District).

(B) Ground Story Height.

- 1) Non-residential uses.
 - (a) The Ground Story finished floor elevation shall be no lower than the average fronting exterior sidewalk elevation; and no higher than eighteen (18) inches above the average fronting sidewalk elevation.
 - (b) The Ground Story shall have a Clear Height of at least fifteen (15) feet contiguous to the Required Building Line frontage for a minimum depth of twenty-five (25) feet.
- 2) Residential Units at the Required Building Line.
 - (a) The finished floor elevation shall be no less than three (3) feet.

- (b) The Ground Story shall have a Clear Height of at least nine (9) feet.
- (c) Main entrances and lobbies may be at grade, with transitions to meet the minimum finished floor elevation for the units within the building interior.

(C) Upper Story Height.

The minimum Clear Height for each upper Story is nine (9) feet.

(D) Street Walls.

A Street Wall not less than four (4) feet in height or greater than eight (8) feet in height shall be required along any Required Building Line frontage when:

- 1) At-grade parking is located inside the parking setback line; or
- 2) Refuse storage areas or bulk material storage areas are present in view from the street.

(iii) Siting.

(A) Façade.

- 1) On each lot a minimum of seventy-five (75) percent of the building Façade shall be built to the Required Building Line.
- 2) A forecourt may be constructed along up to twenty-five (25) percent of the Required Building Line for a building where:
 - (a) The forecourt is surrounded on three (3) sides by the building;
 - (b) The surrounding elevations meet all Façade requirements; and
 - (c) The forecourt shall not provide automobile access other than for emergency services.
- 3) Within sixteen (16) feet of the Block Corner, the Ground Story Façade may be chamfered to form a corner entry.

(B) Buildable Area.

The Buildable and Open Area are shown in Figure 4.2-8. Improvement of open area shall follow the requirements of Section 29-4.2(d)(7).

(C) Garage and Parking.

Openings in any Required Building Line for parking garage entries shall have a maximum Clear Height no greater than sixteen (16) feet and a clear width no greater than twenty-two (22) feet.

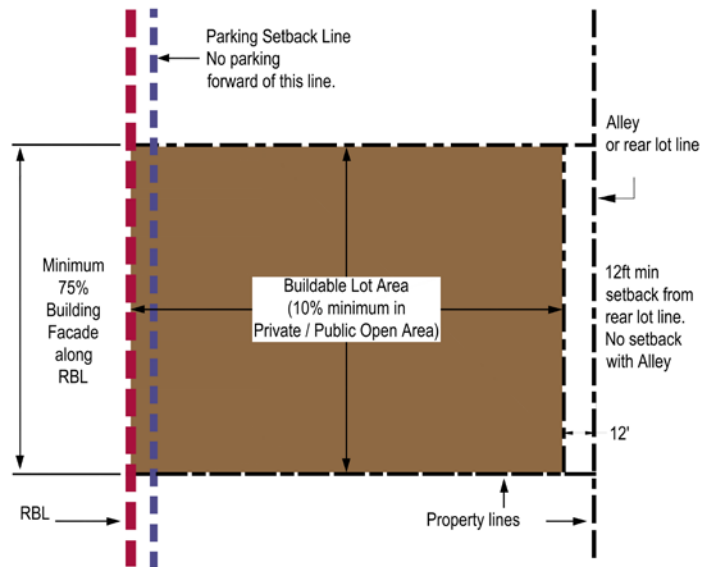

Figure 4.2-8: Urban General/Urban Storefront Siting Standards

(iv) Elements.

(A) Fenestration.

- 1) Blank lengths of wall exceeding twenty (20) linear feet are prohibited on all Required Building Lines.
- 2) For Urban General frontages, Ground Story Fenestration shall comprise between thirty-three (33) percent and eighty (80) percent of the Ground Story Façade.
- 3) For Urban Storefront:
 - (a) Ground Story Fenestration shall comprise between fifty (50) percent and ninety (90) percent of the Ground Story Façade.
 - (b) Single panes of glass shall not be permitted larger than ten (10) feet in height by five (5) feet in width.
 - (c) Ground Story windows may not be made opaque by window treatments (excepting operable sunscreen devices within the conditioned space). A minimum of eighty (80) percent of the window surface shall allow a view into the building interior for a depth of at least fifteen (15) feet.
- 4) Upper Story Fenestration shall comprise between twenty (20) percent and seventy (70) percent of the Façade area per Story.

(B) Building Projections.

Shopfronts may extend up to twenty-four (24) inches beyond the Façade.

(C) Vertical Façade Composition.

Vertical façade compositions shall vary within the Façade of a building as required. If a building exceeds the maximum street frontage without a change in façade, an average maximum façade composition across the block face, including other buildings, shall be a permitted adjustment.

(D) Street Walls.

One access gate no wider than twenty-two (22) feet and one pedestrian entry gate no wider than five (5) feet shall be permitted within any required Street Wall.

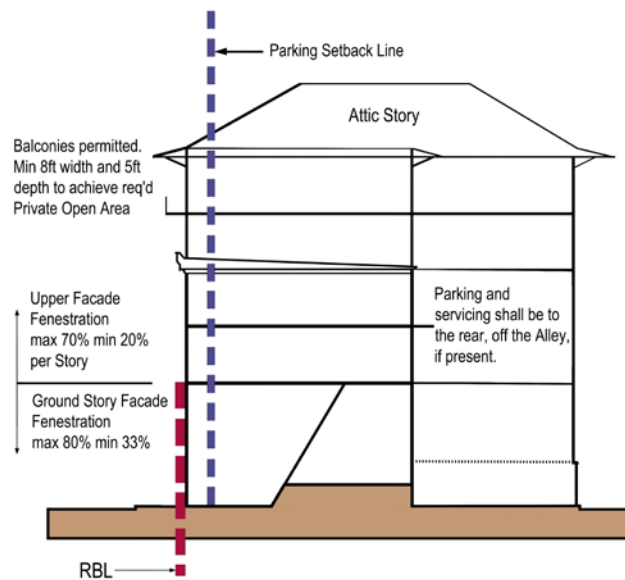

Figure 4.2-9: Urban General/Urban Storefront Element Standards

(v) Use.

(A) Ground Story.

The Ground Story may only house commercial, industrial, residential, public or institutional uses, as prescribed in Chapter 29-3. See height specifications above for specific requirements unique to each use.

(B) Upper Stories.

- 1) The upper Stories may only house residential or commercial uses. *Rooftop Food and Beverage Services are only permitted in the locations designated for Core Height on the Regulating Plan or if the rooftop is accessory or ancillary to a ground floor food service use. In all other locations, no food and beverage services uses shall be allowed in upper Stories unless they are second Story extensions accessory to the Ground Story use.

- 2) No commercial use is permitted above a residential use unless there is a separate access to the commercial use.
- 3) Additional habitable space is permitted within the roof where the roof is configured as an Attic Story.

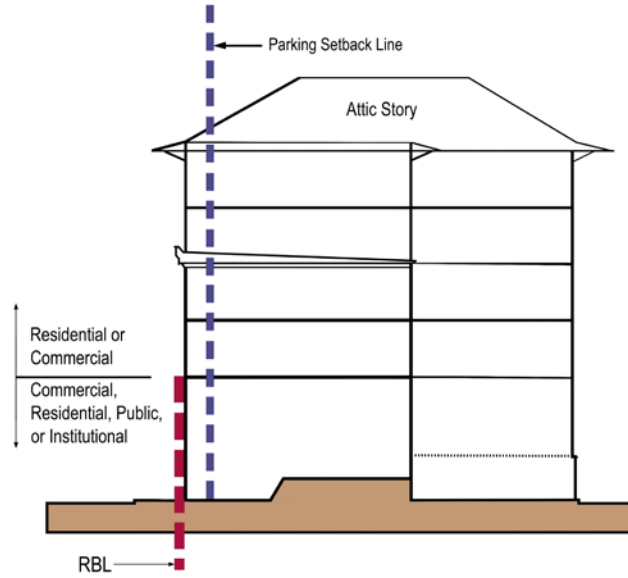

Figure 4.2-10: Urban General/Urban Storefront Use Standards

(2) Urban General – West Frontage.

(i) Illustrations and Intent.

This frontage is to be used in those portions of the Regulating Plan colored gold.

The Urban General-West frontage addresses the evolving area of west Downtown Columbia. Given Columbia’s emphasis on sustainability and multi-modal transportation issues, more compact, urban land-use patterns are appropriate for this area. This frontage fosters single and multi-story buildings, placed to the front of their lot, with windows and one or more entrances onto the sidewalk. The uses may range from commercial to residential, municipal to retail and restaurants. Several buildings could stand shoulder to shoulder along a Block Face, or a single building might fill a smaller block. Less intense than downtown, this frontage anticipates a gradual increase in pedestrian traffic over time. It provides improved pedestrian connectivity and transition to the adjacent neighborhoods. The photos illustrate the range of buildings that could be constructed under this frontage.



National chains can provide street-oriented buildings.



This frontage can accommodate large format, single use buildings or compact, mixed-use ones.



Street-oriented Civic building supports walkability.



Parking located to the side, with low Street Wall defining pedestrian realm.

(ii) Height.

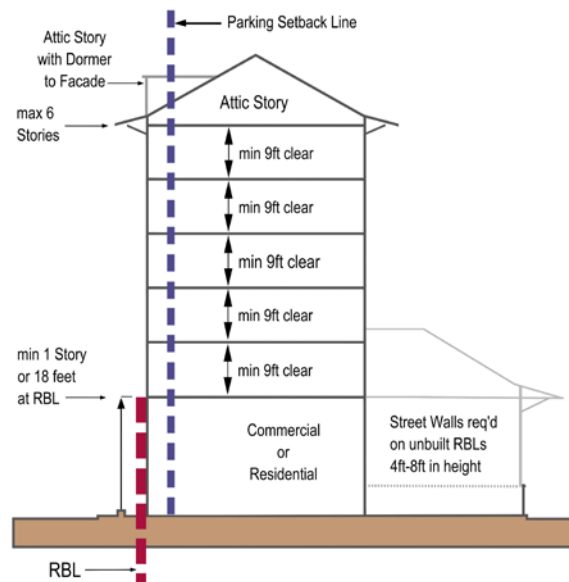

Figure 4.2-11: Urban General West Height Standards

(A) Building Height.

The building shall be at least one (1) Story and eighteen (18) feet in height at the Required Building Line, but no greater than six (6) Stories and seventy-eight (78) feet in height, unless otherwise designated on the Regulating Plan.

(B) Ground Story Height.

1) Non-residential uses.

- (a) The Ground Story finished floor elevation shall be no lower than the average fronting exterior sidewalk elevation and no higher than eighteen (18) inches above the average fronting sidewalk elevation.
- (b) The Ground Story shall have a clear height of at least twelve (12) feet contiguous to the Required Building Line frontage for a minimum depth of twenty-five (25) feet.

2) Residential Units at the Required Building Line.

- (a) The Ground Story shall have a Clear height of at least nine (9) feet.
- (b) Main entrances and lobbies may be at grade, with transitions to meet the minimum finished floor elevation for the units within the building interior.

(C) Upper Story Height.

The minimum clear height for each upper Story is nine (9) feet.

(D) Street Wall Height.

A Street Wall shall be constructed to adequately screen any refuse or outdoor storage area or surface parking lot. When required, a Street Wall shall not be less than four (4) feet or greater than eight (8) feet in height.

(iii) Siting.

(A) Façade.

- 1) On each lot a minimum of thirty-five (35) percent of the building Façade shall be built to the Required Building Line.
- 2) Within eight (8) feet of the Block Corner, the Ground Story Façade may be chamfered to form a corner entry.

(B) Buildable Area and Open Area.

The Buildable and Open Area are shown in Figure 4.2-12.

- 1) The Ground Story may sit anywhere within the buildable area.
- 2) A second Story and above, shall only be within the Buildable Area within one hundred (100) feet of the Required Building Line.
- 3) Where private access drives are configured as recommended M-DT street types, a new Required Building Line shall be created.
- 4) Private or Public Open Area shall be provided in accordance with the provisions of Section 29-4.2(d)(7).

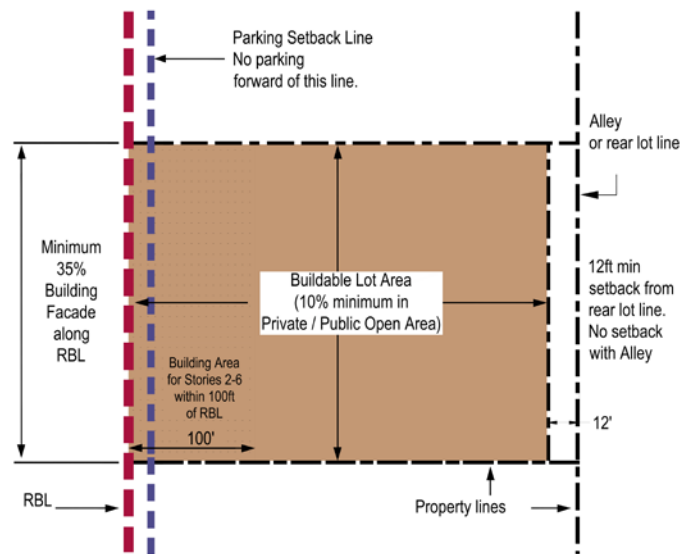

Figure 4.2-12: Urban General West Siting Standards

(C) Garage and Parking.

Openings in any Required Building Line for parking garage entries shall have a maximum clear height no greater than sixteen (16) feet and a clear width no greater than twenty-two (22) feet.

(iv) Elements.

(A) Fenestration.

- 1) Blank lengths of wall exceeding thirty (30) linear feet are prohibited on all Required Building Lines.
- 2) Ground Story Fenestration shall comprise between thirty-three (33) percent and eighty (80) percent of the Ground Story Façade.
- 3) Upper Story Fenestration shall comprise between twenty (20) percent and seventy (70) percent of the Façade area per story.

(B) Vertical Façade Composition.

No greater than the average street frontage length of seventy-five (75) feet per Block Face.

(C) Street Walls.

One (1) access gate no wider than twenty-two (22) feet and one (1) pedestrian gate no wider than five (5) feet shall be permitted in any required Street Wall.

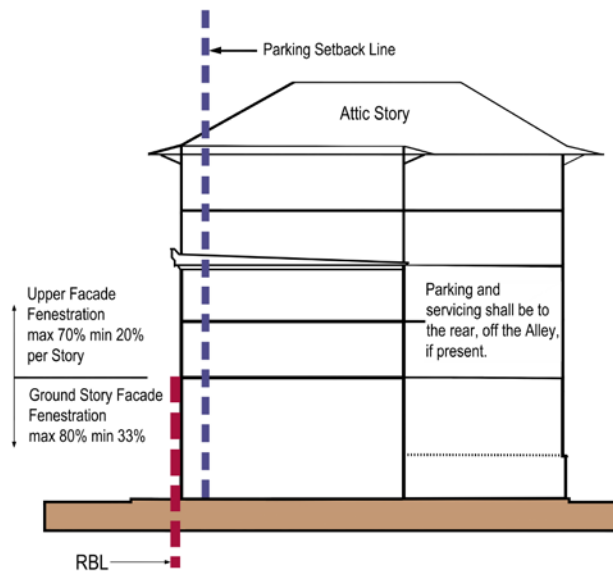

Figure 4.2-13: Urban General West Elements Standards

(v) Uses.

(A) Ground Story.

The Ground Story may only house commercial, residential, public or institutional uses, as prescribed in Chapter 29-3. See height specifications above for specific requirements unique to each use.

(B) Upper Stories.

- 1) The upper Stories may only house residential or commercial uses. No food and beverage services uses shall be allowed in upper Stories unless they are second Story extensions accessory the Ground Story use.
- 2) No commercial use is permitted above a residential use.
- 3) Additional habitable space is permitted within the roof where the roof is configured as an Attic Story.

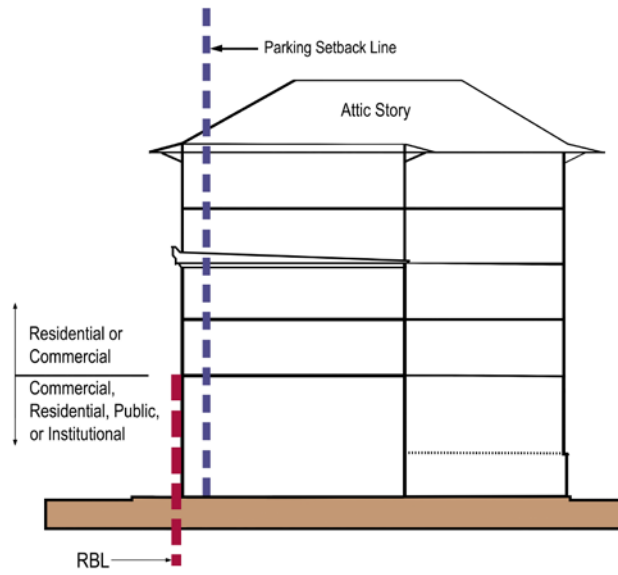

Figure 4.2-14: Urban General West Use Standards

(3) Townhouse/Small Apartment Frontage

(i) Illustrations and Intent.

This frontage is to be used for those properties fronting a blue colored Street-Space on the Regulating Plan.

The Townhouse/Small Apartment frontage is of moderate intensity, often created by a series of smaller attached structures configured as single-family residential or stacked flats. This Building Form Standard has regular Street-Space entrances as frequently as eighteen (18) feet. The character and intensity of this frontage varies depending on the Street-Space and the location of the Required Building Line—the buildings may be placed up to the sidewalk with Stoops, or further back with small Dooryard gardens and/or Front Porches. Similar in scale to the townhouse and row house, a small apartment is of limited size and can also be used to transition from the more intense areas of the M-DT District to adjacent single-family neighborhoods. It is anticipated that the pedestrian activity along these frontages will vary considerably based on the time of day and week. This frontage accommodates office uses. The photos illustrate the range of buildings that could be constructed under the Townhouse/Small Apartment frontage.



This frontage accommodates a range of Townhouses and Small Apartments in a range of building scales and configurations -- but all are street oriented.

(ii) Height.

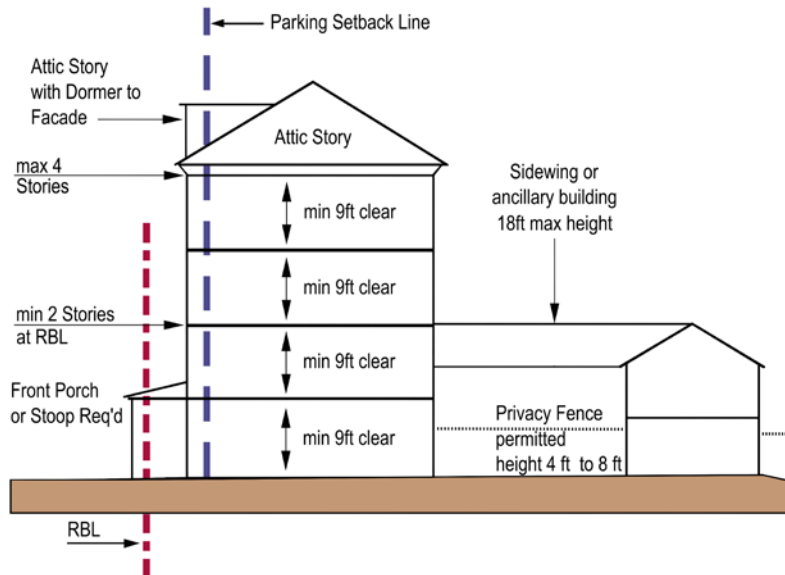

Figure 4.2-15: Townhouse/Small Apartment Height Standards

(A) Building Height.

- 1) Each building shall be at least two (2) Stories high at the Required Building Line, but no more than four (4) Stories with a building height of fifty-eight (58) feet, unless otherwise designated on the Regulating Plan.
- 2) A Sidewing or ancillary structure shall be no higher than eighteen (18) feet in height.

(B) Ground Story Height.

- 1) When English Basement Accessory Units are proposed within a building, the finished floor elevation of the first floor shall be no more than eight (8) feet above the average exterior sidewalk elevation at the Required Building Line. Ground story residential units, when no English Basement Accessory Unit is to be proposed, may be located at grade and are not required to be elevated above the exterior sidewalk.
- 2) At least eighty (80) percent of the Ground Story shall have an interior Clear Height of at least nine (9) feet.
- 3) Main entrances may be at grade, with transitions to meet the minimum finished floor elevation within the building interior.

(C) Upper Story Height.

At least eighty (80) percent of each upper Story shall have an interior Clear Height of at least nine (9) feet.

(D) English Basements.

The finished floor level of an English Basement shall be no greater than five (5) feet below the average elevation of the fronting sidewalk.

(iii) Siting.

(A) Façade.

On each site, the building Façade shall be built to:

- 1) A minimum of sixty-five (65) percent of the Required Building Line, or
- 2) A line an additional eight (8) feet behind the Required Building Line (only permitted to accommodate Front Porch depth—see Elements subsection for Front Porch requirements) with a width not less than sixty-five (65) of the building façade.

(B) Buildable and Open Area.

The Buildable and Open Area are shown in Figure 4.2-16.

- 1) A Private or Public Open Area equal to at least fifteen (15) percent of the total Buildable Area shall be preserved on every lot which may be satisfied through the Balconies of individual units, or rooftops, regulated in Section 29-

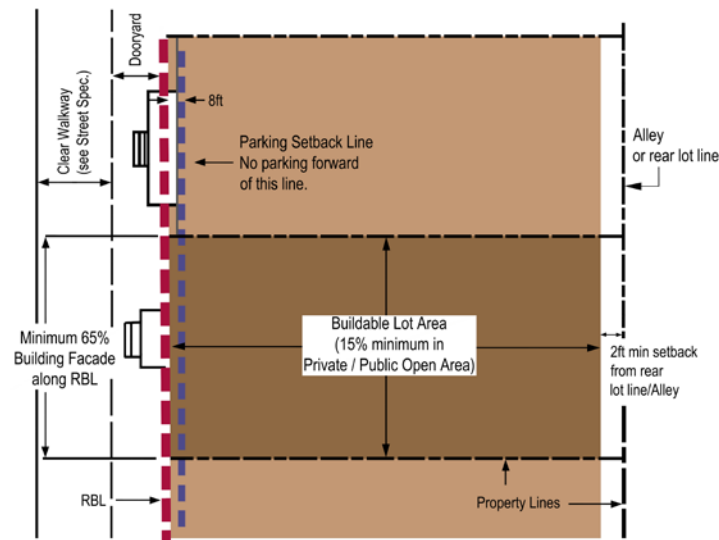

Figure 4.2-16: Townhouse/Small Apartment Siting Standards

4.2(e)(9))(7).

(C) Garage and Parking.

- 1) Garage doors/entries are not permitted on any Required Building Line/Façade.
- 2) At-grade parking may be forward of the Parking Setback Line only when it is within a garage on a corner lot and the parking area's Required Building Line frontage is less than twenty-five (25) feet.

(D) Frontage Widths.

- 1) The minimum width for new townhouses is eighteen (18) feet.
- 2) Although there are no individual lot side setbacks, no individual small apartment building or set of townhouses may exceed one hundred (100) feet of street-space frontage. A gap of ten (10) to twenty (20) feet is required between each building or set of townhouse buildings.

(iv) Elements.

(A) Fenestration.

- 1) Blank lengths of wall exceeding fifteen (15) linear feet are prohibited on all Façades.
- 2) Fenestration shall comprise between twenty-five (25) percent and seventy (70) percent of the Façade.
- 3) Each townhouse and/or small apartment building shall include a functioning Street-Space entry.

(B) Vertical Façade Composition.

No greater than the average street frontage length of seventy-five (75) feet per Block Face.

(C) Building Projections.

- 1) Each townhouse shall include either:
 - (a) A Stoop of not more than four (4) feet deep and six (6) feet wide (not including steps); or
 - (b) A Front Porch, between eight (8) and ten (10) feet deep that projects no more than two (2) feet forward of the Required Building Line, and has a width not less than sixty-five (65) percent of the Required Building Line.
- 2) A Small Apartment may be configured with a Stoop or Front Porch or with a main entrance at grade.

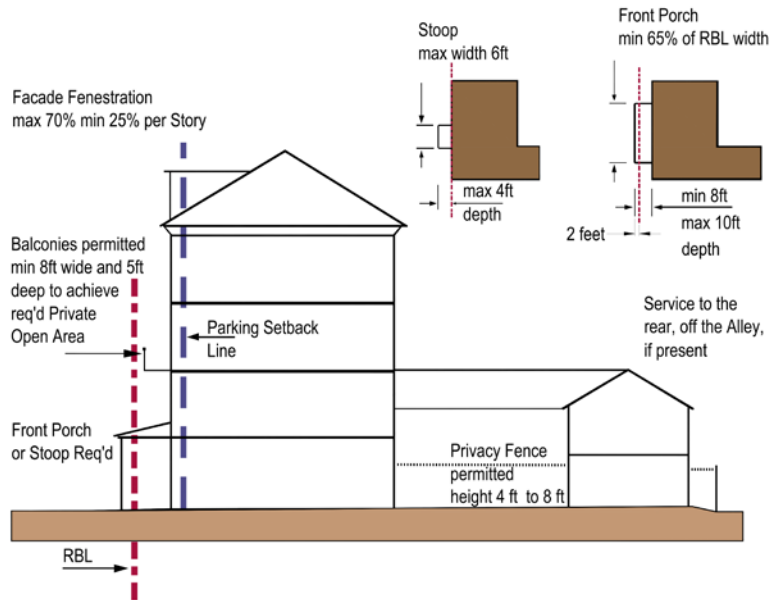

Figure 4.2-17: Townhouse/Small Apartment Elements Standards

(v) Use.

(A) All Stories.

- 1) Only residential, guest accommodation, and office uses are permitted.
- 2) Individual townhouses shall have no more than two (2) residential units, including an accessory unit.
- 3) Additional habitable space is permitted within the roof where the roof is configured as an Attic Story.

(B) Ground Story Exceptions.

Neighborhood serving retail is permitted on the Ground Story of buildings located at a Block Corner and in buildings sharing a lot line with an established block corner commercial space.

(C) Accessory Dwelling Units in M-DT.

- 1) English Basement Accessory Dwelling Units are only permitted in townhouses.
- 2) Only one (1) Accessory Dwelling Unit is permitted per townhouse.
- 3) On townhouse sites, a detached dwelling unit is permitted in the buildable area at the rear of the site or lot line subject to the provisions of 29-3.3(gg)(4).

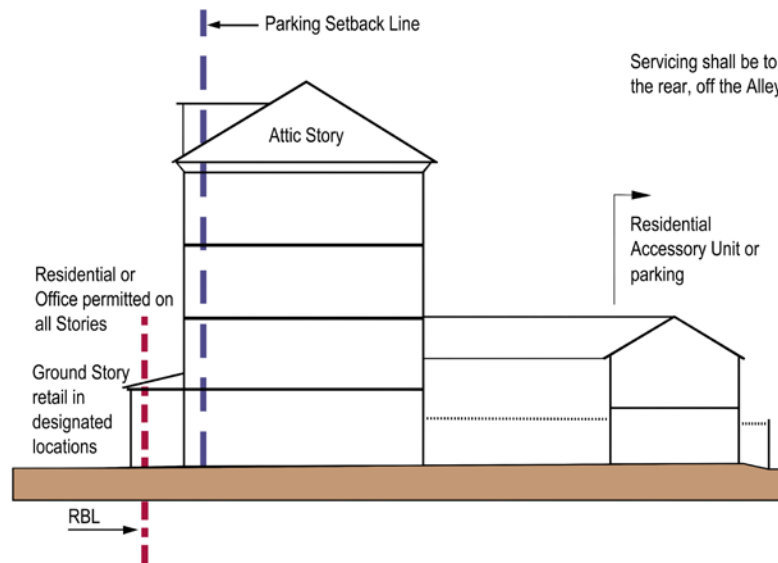

Figure 4.2-18: Townhouse/Small Apartment Use Standards

29-4.2(f) - M-DT Urban Space Standards.

The Urban Space Standards show the relationship between new development or redevelopment and the streets and other public (and publicly accessible) spaces in the M-DT District.

(1) Applicability.

The Urban Space Standards apply to the area between building frontages and the curb line of existing or proposed streets in the M-DT District, and are intended to ensure the coherence and pedestrian-friendliness of the Street-Space. These standards are intended to supplement the City's existing street and sidewalk standards promulgated by the Department of Public Works. In case of a direct conflict between these standards and the City's street and sidewalk standards, the existing street and sidewalk standards shall apply.

(2) Street-Space Standards.

(i) General Provisions

(A) All plant material shall comply with Section 29-4.4 Landscaping and Screening.

(B) Mechanical and electrical equipment including, but not limited to the following, may not be stored or located within any Street-Space:

- 1) Air compressors,
- 2) Pumps,
- 3) Exterior water heaters,
- 4) Water softeners,

- 5) Private garbage cans (not including public sidewalk waste bins), and
- 6) Storage tanks.

(C) Water pumps for public fountains or irrigation not visible are not included in this prohibition and temporary placement of private garbage cans within the Street-Space may be allowed to accommodate scheduled refuse pick-up.

(ii) Street-Space Plantings.

Invasive species, as identified by the Missouri Department of Conservation's invasive species list, are prohibited within Dooryards and on all parcels in the M-DT District.

(iii) Street-Space Elements.

(A) At the time of development, the developer is required to install streetlights and sidewalks, as illustrated in the Street Type Specifications, on the Street-Space frontage being developed.

(B) Sidewalks not otherwise designated in the Regulating Plan or Street Type Specifications shall provide a minimum six-foot Clear Walkway and be constructed to meet all existing standards and specifications.

(C) Street furniture is an element of the overall Street-Space design. Street furnishings should be simple, functional, and durable.

(iv) On-Street Parking.

(A) On-street parking spaces fronting a development project may count towards any parking requirements required under Section 29-4.3 (Parking and Loading).

(B) The parking space/tree planting pattern may be interrupted by existing or new driveways designated in the Regulating Plan, streets, and Alleys, but spacing shall not exceed forty-five (45) feet on center except where necessary for transit stops and stations.

(v) Pedestrian Pathways.

The area within a Pedestrian Pathway shall be a public access easement or public right-of-way. The easement width for these pathways must not be less than twenty (20) feet with a paved walkway not less than ten (10) feet wide providing an unobstructed view straight through its entire length, except where otherwise specified on the Regulating Plan.

(3) Street-Type Recommendations.

The Street Type Recommendations located in Appendix A illustrate model configurations for the Street-Spaces within the M-DT. The plans and sections specify vehicular travel lane widths, curb radii, sidewalks, Dooryards, tree planting areas, and on-street parking configurations. Dooryards and Alleys are generally reserved for utility easements.

29-4.3 Parking and Loading.**29-4.3(a) – Applicability.**

- (1) General Requirements.
 - (i) The standards of this Section 29-4.3 shall apply to all development and redevelopment, unless specifically excluded or modified by another provision of this Code.
 - (ii) Required off-street parking areas in existence on November 19, 2001, shall not be reduced below, or if already less than, shall not be further reduced below, the requirements for such use as would be required for the use as a new use of a building, structure or premises under the provisions of this section.
- (2) Exceptions.
 - (i) M-DT District (Section 29-4.2).
 - (A) Development and redevelopment in the M-DT District is exempt from the minimum parking requirements in Table 4.3-1.
 - (B) Residential development and redevelopment in the M-DT District shall provide one-quarter (0.25) of one parking space per bedroom. This requirement can be satisfied on the site or within one-quarter (0.25) mile (1,320 feet) of the site. Measurement of the walking distance shall be from entrance to entrance.
 - (C) If on-site parking is provided, it shall meet all other requirements of this Section 29-4.3 and may not be located forward to the Parking Setback Line pursuant to the Building Form Standards in Section 29-4.2 (M-DT District).
 - (D) On-street parking shall meet the on-street parking requirements in Section 29-4.2(f)(2)(iv).
 - (ii) Small Lots.
 - (A) No off-street parking shall be required for any non-residential primary use on a lot in any Mixed Use District that is smaller than ten thousand (10,000) square feet of gross floor area, provided no portion of the front lot line of the property is located within one hundred (100) feet of a residential district.
 - (B) No off-street parking shall be required for any building in any Mixed Use District that contains a non-residential primary use that is less than ten thousand (10,000) square feet of gross floor area, provided no portion of the front lot line of the property containing that building is located within one hundred (100) feet of a residential District.
 - (iii) Planned Development.

The off-street parking requirements of this section shall serve as the standard from which to request different parking requirements for a proposed use in a PD (Planned Development) District. Following approval of a PD District that is subject to an approved site plan with parking requirements that differ from those in this Section 29-4.3, the requirements of this Section shall not apply to property located in that district.

If an approved planned zoning district site plan is silent on any aspect of parking addressed by this section, the provisions of this section shall apply to that aspect of parking.

(iv) Historic Properties.

- (A) No new on-site parking shall be required for the redevelopment of Historic Structures.
- (B) If an existing Historic Structure has on-site parking, such parking must be retained and conform to the City's current parking improvement standards (e.g., be paved), unless the Director determines that compliance is impracticable or would compromise the historic character of the property or area.

(3) Residential Districts.

The following standards apply in all residential districts:

- (i) No detached garage shall be located nearer than twenty (20) feet to the front lot line or behind the building front, whichever is greater.
- (ii) Parking spaces for residential and non-residential uses, other than single-family and two-family dwellings, shall not be located in the required front yard.
- (iii) Required parking spaces may be tandem spaces to serve one- and two-family dwellings only, as exhibited in the Figure 4.3-1, provided no portion of the parked vehicles extends into the public right of way or any separate street or sidewalk easement.

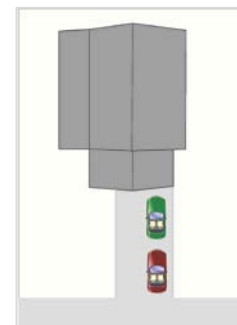

Figure 4.3-1: Tandem Parking

(4) Change in Permitted Use.

- (i) When the intensity of use of any legally established building, structure or premises is increased resulting in a net increase of gross floor area, net increase of dwelling unit(s), or any other unit of measurement specified herein for determining required parking areas, parking spaces and any other facilities as required herein shall be provided for such increase in intensity of use.
- (ii) Whenever the type of use of a building, structure or premises is changed to a new type of use permitted by this Chapter, parking spaces and areas shall be provided as required by the provisions of this Section for such new type of use.
- (iii) Notwithstanding the provisions of subsections (i) and (ii) above, a permitted use that does not meet the parking requirements of this Section may be converted to another permitted use without full compliance with the required number of parking spaces provided:
 - (A) The amount of parking available is at least seventy-five (75) percent of the parking required for the new use in Table 4.3-1.

- (B) The applicant provides the maximum number of parking spaces able to be accommodated on the site while complying with all other provisions of this Code and without being required to remove or partially remove an existing structure.

29-4.3(b) - Parking Requirements

- (1) Required Parking Spaces.

The minimum and maximum off-street parking requirements for all uses allowed by this Code are listed in Table 4.3-1.

- (2) Accessible Parking.

Within the requirements of Table 4.3-1, accessible parking shall be provided for all multi-family and non-residential uses as required by the Americans with Disabilities Act (ADA) and City Code requirements.

Table 4.3-1: Minimum Required Off-Street Parking (and Maximum Permitted Off-Street Parking for Selected Uses) sf = square feet; gfa = gross floor area	
Category	Standard
RESIDENTIAL USES	
Household Living	
Dwellings, One-Family Detached	2 spaces/dwelling unit
Dwelling, One-Family Attached	
Dwelling, Two-Family	
Dwelling, Live-Work	1 space/dwelling unit
Dwelling, Multi-family	1.0 spaces/dwelling unit for "efficiency" apartment (i.e., units without a separate bedroom); 1.5 spaces/dwelling unit for 1 bedroom units; 2 spaces/dwelling unit for 2 bedroom units; 2.5 spaces/dwelling for 3 or more bedroom units; In addition to required parking for residents, 1 space/5 dwelling units will be required for visitor parking
Manufactured Home Park	2 spaces/dwelling unit
Second Primary Dwelling Unit	1 space/dwelling unit
Group Living	
Boardinghouse	1 space/3 guests design capacity
Continuing Care Retirement Community	1 space/ 3 habitable units
Dormitory/Fraternity/Sorority	1 space/2 occupants the building is ultimately designed to accommodate. Community Development director may reduce requirements for dorms by not more than 20% during such periods students are not permitted autos.

Table 4.3-1: Minimum Required Off-Street Parking (and Maximum Permitted Off-Street Parking for Selected Uses) sf = square feet; gfa = gross floor area	
Category	Standard
Group Care Home, Large	1 space/ 2 beds design capacity
Group Home, Small	
Halfway House	
Residential Care Facility	1 space/ 6 beds, but not less than 2 spaces
Temporary Shelter	1 space per 4 occupants design capacity.
PUBLIC and INSTITUTIONAL USES	
Adult and Child Care	
Adult Day Care Center Family Day Care Center	1 space/ 800 sf gfa plus 2 additional spaces or "pull-over" space for 2 vehicles out of the flow of driveway traffic.
Community Service	
Assembly or Lodge Hall	1 space/200 sf gfa
Cemetery or Mausoleum	No requirement
Community/Recreation Center	1 space / 500 sf gfa
Elementary School	1 space / 10 seats in the auditorium or main assembly room, or 1 space/ classroom, whichever is greater
Secondary School (middle and high)	1 space / 6 seats in the main auditorium or 3 spaces/ classroom, whichever is greater.
Funeral Home or Mortuary	1 space/ 6 seats or per 200 sf gfa in main assembly area, whichever is greater
Higher Education Institution	1 space/ 500 sf gfa of office, research, and library area plus 1 space/ 200 sf gfa of auditorium space
Hospital	1 space/ 500 sf gfa
Museum or Library	1 space/ 1,000 sf gfa
Police or Fire Station	No requirement
Public Service Facility	1 space/ 300 sf gfa
Public Park, Playground	Park/Playground: 1 space/5,000 sq. ft. of land area; Playfield (e.g., baseball, soccer): 20 spaces/field (min.)
Golf Course	1 space / 400 sq. ft. of clubhouse area or 6 spaces / hole, whichever is greater
Religious Institution	1 space/ 6 seats or per 200 sf main assembly area, whichever is greater
Reuse of Place of Public Assembly	No requirement

Table 4.3-1: Minimum Required Off-Street Parking (and Maximum Permitted Off-Street Parking for Selected Uses) sf = square feet; gfa = gross floor area	
Category	Standard
COMMERCIAL and INDUSTRIAL USES	
Agricultural & Animal Related	
Agriculture	No requirement
Farmer's Market	1 space/booth; host property parking may apply if farmer's market does not leave host use deficient
Greenhouse or Plant Nursery	1 space/ 1,000 sf gfa
Pet Store or Pet Grooming	1 space/ 300 sf gfa
Urban Agriculture	No requirement
Veterinary Hospital	1 space/ 400 sf gfa
Food & Beverage Service	
Bar or Nightclub	1 space/ 150 sf gfa
Restaurant (no drive-through)	1 space/ 150 sf gfa
Restaurant (with drive-through)	1 space/ 200 sf gfa Refer to Table 4.4-3 for drive-through stacking space requirements
Guest Accommodations	
Bed and Breakfast	1 space/ manager plus 1 space/ dwelling unit
Hotel or motel	2 spaces/ 3 guest rooms plus 1 space/ 200 sf gfa in all accessory uses including restaurants and meeting rooms
Travel Trailer Park	1 space / 1,500 sf of land area
Office	
Commercial or Trade School	1 space/ 400 sf of enclosed floor space
Office	1 space/ 300 sf gfa (General) 1 space/ 200 sf gfa (Medical)
Research and Development Laboratory	1 space/ 600 sf gfa
Wholesale Sales Offices and Sample Room	1 space/ 600 sf gfa
Personal Services	
Personal Services, General	1 space/ 400 sf gfa
Self-service Storage Facilities	1 space/ 20 storage units
Tree or Landscaping Service	1 space/ 1,000 sf gfa
Recreation & Entertainment	
Indoor Recreation or Entertainment Physical Fitness Center	General: 1 space/ 400 sf gfa Indoor Theater: 1 space per each 6 seats design capacity

Table 4.3-1: Minimum Required Off-Street Parking (and Maximum Permitted Off-Street Parking for Selected Uses) sf = square feet; gfa = gross floor area	
Category	Standard
Indoor Entertainment, Adult	1 space/ 400 sf gfa
Outdoor Recreation or Entertainment	General: 1 space/ 5,000 sf of land area, or 1 space/ 3 person design capacity, whichever is less; Swimming Pools: 1 space / 200 sf of pool surface area
Theater, Drive-In	No requirement
Retail	
Alcoholic Beverage Sale	1 space/ 300 sf gfa
Retail, General, Small Retail, Adult, Small	1 space/ 300 sf gfa
Retail, General, Large Retail, Adult, Large	1 space/ 400 sf gfa
Vehicles & Equipment	
Car Wash	2 stacking/drying spaces/stall
Heavy Vehicle and Equipment Sales, Rental, and Servicing	1 space/ 1,000 sf gfa
Light Vehicle Sales or Rental	1 space/ 500 sf gfa
Light Vehicle Service or Repair	1 space/ 500 sf gfa
Parking Lot, Commercial	
Parking Structure, Commercial	
INDUSTRIAL USES	
Commercial Services	
Heavy Commercial Services	1 space/ 750 sf gfa
Mechanical and Construction Contractors	1 space/ 1,000 sf gfa
Warehousing and Storage	1 space/ 2,000 sf gfa
Wholesale Distribution	1 space/ 2,000 sf gfa
Manufacturing, Production, and Extraction	
Artisan Industry	1 space/ 1,000 sf gfa
Bakery	
Heavy Industry	
Light Industry	
Machine Shop	
Mine or Quarry	No requirement
Transportation	
Airport	As determined by the Columbia Regional Airport management

Table 4.3-1: Minimum Required Off-Street Parking (and Maximum Permitted Off-Street Parking for Selected Uses) sf = square feet; gfa = gross floor area	
Category	Standard
Bus Barn or Lot	No requirement
Bus Station	
Rail or Truck Freight Terminal	
Waste & Salvage	
Sanitary Landfill	No requirement
Automobile Wrecking and Junk Yard	
ACCESSORY USES	
Accessory Dwelling Units	1 space/ dwelling unit for accessory dwelling units having up to 2 bedrooms
Drive-Up/Through Facility	Refer to Table 4.4-3 for drive-through stacking space requirements
All other accessory uses	No requirement
TEMPORARY USES	
Temporary Construction Yard or Office	2 spaces
Temporary Real Estate Sales/Leasing Office	2 spaces
All other temporary uses	No Requirement

29-4.3(c) - Other Parking Requirements.

For any use not listed in Table 4.3-1, the required minimum number of off-street parking spaces shall be determined by the Director based on the anticipated use and anticipated neighborhood and traffic congestion impacts.

29-4.3(d) - Parking Alternatives.

The Director may approve applications containing alternatives to providing the number of off-street parking spaces required by Table 4.3-1, in accordance with the following standards:

- (1) Transit Incentives.
 - (i) The minimum number of off-street parking spaces required for any development or redevelopment of land located within one-quarter ($\frac{1}{4}$) mile of the City of Columbia transit center or immediately adjacent to transit lines that serve as a connection point for at least four other transit lines, may be reduced by twenty (20) percent.
 - (ii) The minimum number of off-street parking spaces required for any development or redevelopment of lands zoned M-N (pedestrian) or M-C (transit), may be reduced by thirty (30) percent. This reduction may not be combined with the reductions in subsection (i) above.

- (iii) Upon application of the owner, the parking requirement of a building or use may be reduced by five (5) percent if the lot or tract is at least two (2) acres, is located on a transit route, and the owner provides, at the owner's cost, transit pull-offs and transit rider shelters of a type and location acceptable to the City.
 - (iv) If an existing transit route, center, or zoning district is eliminated or changed in location, any development approved and built in conformance with this Section 29-4.3 shall not be deemed nonconforming in terms of required parking.
- (2) Shared Parking.

The Director may approve joint parking facilities for development or uses with different operating hours or different peak business periods, if the shared parking complies with the following standards:

- (i) Location.

Shared parking facilities may be located on the same site as the proposed uses or within six hundred (600) feet, as measured along the roadway frontage(s) to the center of the parcels upon which the uses are located and have their primary entrance, if the uses are not on the same parcel. Off-site shared parking facilities shall be connected by sidewalks.

- (ii) Shared Parking Facility Parking Space Reduction.

Where a joint parking facility meets the requirements of this subsection, the total off-site parking required for the uses may be reduced by the factors shown in Table 4.3-2. Total off-street parking required shall be the sum of the two (2) parking requirements for the two (2) uses divided by the factors for that combination of uses shown in Table 4.3-2. If more than two (2) uses share a parking lot or structure, the required parking shall be calculated by applying Table 4.3-2 to the two (2) uses with the largest parking requirements and then adding the required parking for the additional use(s).

- (iii) Additional Sharing Permitted.

As an alternative to the shared parking reduction factors in Table 4.3-2, the Director may allow the following reductions in required parking:

- (A) Up to fifty (50) percent of the parking spaces required for food, beverage, and indoor entertainment uses located within six hundred (600) feet of a non-residential use that is not normally open, used, or operated during the same hours; and
- (B) Up to one hundred (100) percent of parking spaces required for religious assembly uses located within six hundred (600) feet of a non-residential use that is not normally open, used, or operated during the same hours.

Table 4.3-2: Shared Parking Reduction Factors					
Property Use	Residential	Public and Institutional	Food, Beverage, and Indoor Entertainment, Lodging, or Religious Assembly	Retail Sales and Personal Services	Office & Other Commercial
Residential					
Public and Institutional	1.1				
Food, Beverage, and Indoor Entertainment, Lodging or Religious Assembly	1.1	1.2			
Retail Sales and Personal Services	1.2	1.3	1.3		
Office & Other Commercial	1.3	1.5	1.7	1.2	

(iv) Agreements.

If the Director determines that in the interest of the public safety and welfare there is a need to ensure shared parking facilities will continue to remain available indefinitely for the buildings or uses they serve, the Director may require a written agreement assuring the continued availability of the shared parking spaces for the buildings or uses they serve. If required by the Director, the agreement shall be on a form approved by the City Counselor, or designee, and approved by the Council.

(3) Credit for Public Parking.

Some or all of the required off-street parking spaces for a non-residential use may be waived by the Director if publicly owned off-street parking is located within a one thousand (1,000) foot walking distance from the main entrance of the proposed use, and the Director also determines that adequate parking spaces are available within the publicly owned parking area to accommodate the anticipated use.

(4) Credit for On-Street Parking.

The Director, after consultation with the Director of Public Works, may credit on-street parking spaces against required off-street parking requirements if the on-street spaces are located within two hundred (250) feet of an entry of the building in which the use is located, if the Director determines that those parking spaces are frequently not utilized by the public, are readily available for residents, patrons, or employees of the proposed use

and structure and granting such credit will not otherwise impair the public health, safety or welfare.

(5) Additional Parking Reductions.

The Director may allow an additional reduction in the required number of parking spaces (less than what may be determined using the adjusted off-street parking calculations in subsections (1) to (4) above) if the applicant submits a parking demand study, prepared by a licensed engineer in accordance with guidelines promulgated by the Director which establishes the basis for granting a reduced number of spaces, and the Director determines the study accurately reflects the foreseeable parking demand for the building and use of the property. In authorizing additional reductions shared access easements or agreements to adjacent parking areas and/or driveways may be required.

29-4.3(e) - Maximum Parking Limit.

- (1) In any Mixed Use District, no single building that contains more than fifty thousand (50,000) square feet of gross floor area, in which a single-user or multiple users operate a use listed in the Retail, Office, or Personal Service categories in Table 29-3.1 (Permitted Use Table), may provide on-site automobile parking in an amount greater than one hundred fifty percent (150%) of the minimum amount required by Table 4.3-1, except as permitted below in subsections (2) and (3).

In the M-DT District (Section 29-4.2), maximum on-site parking is limited to one hundred fifty (150) percent of the minimum amount required for the same use in other Mixed Use Districts, even though those minimums do not apply to the M-DT District.

- (2) The parking on a site may be increased to two hundred percent (200%) of the minimum amount required by Table 4-3.1 provided that:
- (i) Such request is submitted to the Director in writing with justification of why such increase is necessary;
 - (ii) The development site's landscaped area is not reduced to be less than fifteen percent (15%) as a result of the increased parking; and
 - (iii) The interior parking lot landscaping area required by Section 29-4.4(f) shall be increased to twenty percent (20%) and shall comply with the tree planting and/or landscaping standards specified within subsections (1), (2), and (3) of Section 29-4.4(f).
- (3) Parking in excess of two hundred percent (200%) of the minimum amount required by Table 4-3.1 shall require approval of a variance by the Board in accordance with the standards of Section 29-6 of this Chapter.

29-4.3(f) - Location and Use of Parking Facilities.

- (1) Location.
- (i) All required parking shall be provided on the lot(s) where the principal use is located unless otherwise provided by this Chapter.

- (ii) Off-street automobile parking facilities required by this section for all non-residential uses may be located either on the premises of the building or use or within one thousand (1,000) feet of such building or use.
 - (iii) In the M-N District, on-site parking for non-residential uses shall not be located closer to the primary street frontage of the lot than the front façade of the principal structure, except for one (1) double-loaded row of parking, which may be located between the front building façade and the front lot line, if it is not located in a required front yard area. The option to include one (1) double-loaded row of parking in this location is not available on properties where the applicant has selected to use the “pedestrian” dimensional standards shown in Sections 29-2.2(b)(2) (M-N District) and 29-4.1 (Dimensional Standards).
 - (iv) No portion of an off-street parking facility shall be located in a public street or sidewalk, parkway, alley, or other public right-of-way.
 - (v) In a residential district, no paved driveway or outdoor parking area shall be permitted to cover more than thirty percent (30%) or five hundred (500) square feet, whichever is greater, of any required front yard or required rear yard area. The thirty percent (30%) limit shall include areas included in driveways.
- (2) Use.
- (i) Land used for off-site parking for a non-residential generating use shall not be located in a residential District, unless that generating use is a Permitted Use or Conditional Use in that residential District.
 - (ii) Off-street parking spaces shall not be used for the sale, repair, dismantling, or servicing of any vehicles, or equipment.
- (3) Use of Yards.
- (i) No vehicle shall be parked in a required front or side yard except on a permitted driveway. A permitted driveway is a driveway that leads to the front or rear of the building or to a permitted accessory building (garage) attached or detached from the principal structure and maintained in accordance with the City’s property maintenance standards.
 - (ii) A permitted driveway may include a defined area for parking adjacent and attached to the driveway provided such extension does not occupy any part of a required front or side yard and complies with all provisions of Section 29-4.7(d) & (e). The extension must be paved in a material similar to that of the rest of the driveway.
 - (iii) Parking of vehicles in a direction perpendicular to the driveway is prohibited, except in the rear yard.
 - (iv) In residential districts, rear yards may be used for open parking of automobiles, including trailers and similar type vehicles, on an approved dust-free surface, subject to the installation and maintenance of a screening device not less than four(4) feet or more than six (6) feet in height.

- (v) The Director may issue a temporary permit to allow parking that does not meet the requirements of subsections (i) through (iv) under Sec. 29-6.4(h) (Temporary Parking Permits)

29-4.3(g) - Parking Design Standards.

The design of required off-street and open parking areas and spaces shall meet the following standards:

(1) Residential Setback.

No parking shall be permitted within six (6) feet of an adjoining lot containing a single- or two-family use, except as otherwise provided by this Chapter.

(2) Grades, Drainage, and Curbs.

- (i) Parking areas shall be designed to assure positive drainage, but shall not exceed a slope of ten (10) percent;
- (ii) Approach driveways which do not serve directly abutting parking spaces may be designed to a slope of up to fifteen (15) percent, if accompanied by appropriate landing grades and vertical curves at points of transition;
- (iii) Storm drainage control and facilities shall be designed to satisfy the requirements of the storm drainage standards of the City.
- (iv) Curb islands or wheel stops may be installed for drainage control, and for vehicular channelization and lane control; provided, that in parking areas of more than one hundred (100) spaces, curbing or similar measures shall be required to assure safe and proper control of vehicular and pedestrian movements.
- (v) Parked vehicles shall be prevented from intruding on travel lanes, walkways, public streets, or adjacent properties by means of walls, curbs, wheel stops, or other means.

(3) Access.

- (i) Ingress and egress shall be only by way of paved driveways or openings meeting the City's adopted access location and design requirements.
- (ii) All parking areas containing more than two hundred (200) spaces shall be served by more than one (1) standard entrance.
- (iii) Access driveways shall be free of objects that might interfere with the ability of drivers to see pedestrians and other vehicles.
- (iv) A driveway providing access to premises in commercial or industrial districts shall not be permitted through a residential district.
- (v) The following additional standards apply in all residential districts:
 - (A) No garage for any use other than a single- or two-family dwelling shall be located nearer than sixty (60) feet to the front lot line;
 - (B) Required parking spaces may be provided in a tandem layout (i.e., one vehicle parked behind the other) to serve one- and two-family dwellings only; see Figure 4.3-1 above; and

- (C) Parking spaces for all other uses in residential districts shall not be located in the required front or side yard.
- (vi) Any non-residential driveway not conforming to the City’s adopted design guidelines shall be reviewed and approved by the Director of Public Works.

(4) Parking Layout Dimensions.

All required parking spaces must comply with the minimum dimensions for spaces shown in the following Table 4.3-3 and Figure 4.3-2.

Table 4.3-3: Off-Street Parking Layout Dimensions for Standard Sized Vehicles										
Parking Angle (1)-degree	0°	20°	30°	40°	45°	50°	60°	70°	80°	90°
Curb Length Per Space (3)--ft.	23.0	24.9	17.0	13.0	12.0	11.3	9.8	9.4	9.0	8.5
Space Depth (4)--ft.	8.0	14.5	16.9	18.5	18.8	19.3	20.0	19.5	19.0	18.0
Access Aisle Width (5)--ft.	12.0 ^{[1] [2]}	12.0 ^[1]	12.0 ^[1]	12.0 ^[1]	13.0 ^[1]	15.0 ^[1]	18.0	20.0	22.0	24.0
Space Width (2)—ft.	8.0	8.5	8.5	8.5	8.5	8.5	8.5	8.5	8.5	8.5

[1] Aisle width (D) shall not be less than 18 feet if the aisle is a designated fire lane.
 [2] Aisle width (D) shall not be less than 22 feet for two-way traffic.

- (i) If the degree of angle of parking provided is not listed, the aisle width required shall be the next largest angle of parking shown.
- (ii) If parking spaces are located only on one (1) side of an access aisle, the width of the access aisle may be reduced by twenty (20) percent but not less than twelve (12) feet wide or eighteen (18) feet wide if a designated fire lane.
- (iii) Non-residential driveways shall be a minimum of 30-feet in width with a curb return radius of 30-feet. Non-residential driveways with a width greater than 30-feet up to a maximum of 41-feet must have the driveway throat stripped and approved by the Director of Public Works.

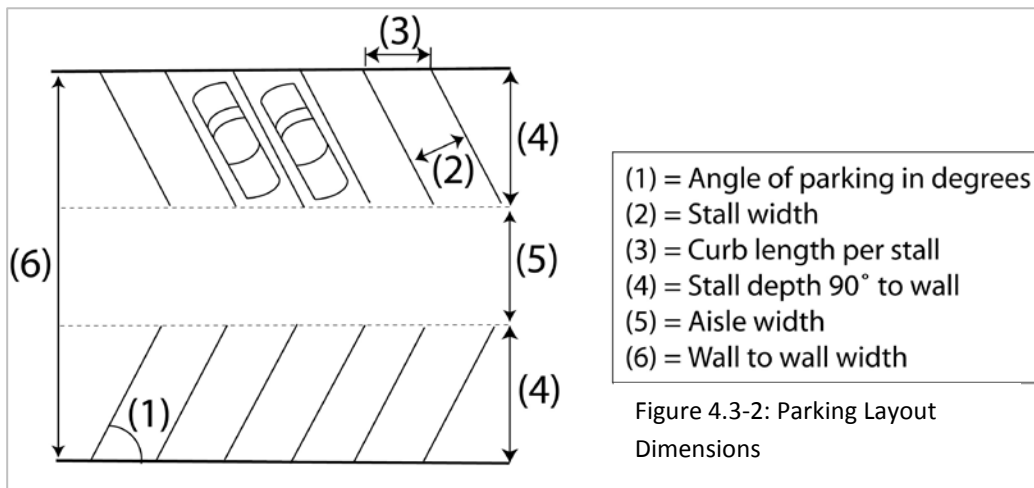

- (5) Surfacing.
- (i) All new and expanded vehicle parking, vehicle storage, and maneuvering areas must be paved with concrete, asphalt, or an alternate paving material as determined by the Director.
 - (ii) Pervious or semi-pervious parking area surfacing materials may be approved alternatives, if the Director determines that such materials are appropriate for the City's climate and the durability required for their intended use. Permitted materials may include, but are not limited to "grasscrete," ring and grid systems used in conjunction with grass seed or sod, permeable concrete or asphalt, porous or grid pavers, or recycle materials such as glass, rubber, used asphalt, brick, block, and concrete.
 - (iii) Pavement cross-section shall be determined by the owner based on considerations of durability, subsurface conditions, and the type of vehicles using the parking area.
 - (iv) Interior driveways, fire lanes, and loading or maneuvering areas shall comply with applicable design and surfacing standards on file in the Community Development Department.
 - (v) Parking spaces shall be delineated and appropriate traffic flow indications given by use of reflectorized paint on the parking area pavement.
- (6) Lighting.
- Lights shall be required for all parking areas intended for night use. Lights shall be arranged or shielded to direct illumination away from residences and from public streets and other public areas in accordance with Section 29-4.5 (Exterior Lighting).
- (7) Exceptions.
- Driveways and off-street parking for one-family and two-family dwellings in the R-1 and R-2 Districts shall not be required to comply with the provisions of subsections (2), (4) and (6) above.

29-4.3(h) - Parking Structure, Commercial or Accessory.

All accessory parking structures, commercial parking structures or portions of structures occupied by automobile parking shall meet the following standards:

- (1) The minimum setback for a parking structure shall be the same that is required for a principal structure.
- (2) The height of an accessory parking garage may not exceed the height of the principal building it is intended to serve.
- (3) Points of ingress and egress to the garage shall be clearly marked and shall be no closer than twenty-five (25) feet to an intersection or other curb cut.
- (4) All floors fronting a public street shall be level (not inclined).

- (5) At least thirty (30) percent of each façade facing a public street shall be designed to conceal the view of all parked cars below the hoodline and to conceal internal light sources when viewed from the public street.
- (6) Where a parking garage is subject to a front, side, or rear setback of ten (10) feet or more, a landscape strip at least four (4) feet wide shall be installed around the perimeter of the garage and comply with the landscape design requirements in Section 29-4.4.
- (7) When a garage is open during the evening hours, all internal areas and all entrances shall be lit with fixtures providing at least two (2) footcandles of light at floor level.

29-4.3(i) - Drive-Through Vehicle Stacking.

The following standards apply to all properties with a drive-through facility.

- (1) Stacking Space Requirements.

Table 4.3-4: Drive-Through Stacking Space Requirements		
Activity	Minimum Stacking Spaces (per lane)	Measured From:
Bank, Financial Institution, or Automated Teller Machine (ATM)	3	Teller or Window
Restaurant/Retail Store	3	Pick-Up Window
Full Service Vehicle Washing Establishment	3	Outside of Washing Bay
Self-Service or Automated Vehicle Washing Establishment	1	Outside of Washing Bay
Other	Determined by the Director based on anticipated need and avoidance of traffic congestion on adjacent streets	

- (2) Location and Design of Stacking Lanes.
 - (i) Minimum number of stacking spaces shall be in addition to the space at the teller or pick-up window.
 - (ii) Audible electronic devices such as loudspeakers, automobile service order devices, and similar instruments shall not be audible beyond the property line of the site.
 - (iii) No service shall be rendered, deliveries made, or sales conducted within the required

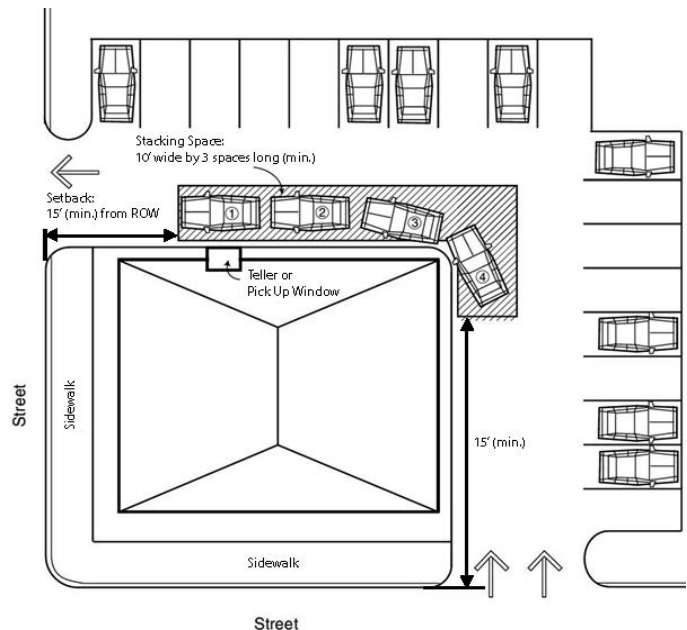

front yard or corner side yard; customers shall be served in vehicles through service windows or facility located on the non-corner sides and/or rear of the principal building.

- (iv) Drive-through stacking lanes shall have a minimum width of ten (10) feet.
- (v) Stacking lanes shall be set back fifteen (15) feet from rights-of-way.
- (vi) A by-pass land around the drive-through facility stacking lane must be provided for financial institutions and restaurant/retail uses.

29-4.3(j) - Off-Street Loading Requirements.

- (1) Minimum Requirements for Off-Street Loading Space.

Off-street loading space shall be provided as set forth in Table 4.3-5 below, except as provided in subsection (2) below.

- (2) Existing Structures.
 - (i) If the aggregate gross floor area of any building is increased by more than 50,000 square feet, off-street loading space shall be provided, in accordance with Table 4.3-5.
 - (ii) Existing buildings greater than fifty (50) years old shall be exempt from the requirement to construct off-street loading space if the gross floor area of the existing building is increased.

Table 4.3-5: Off-Street Loading Space Standards	
Type of Use or Facility	Off-Street Loading Requirement
Office or Lodging Personal services and repair Retail store (large)	1 space for each 50,000 sf of gross floor area in the structure or part thereof shall be provided. If a common loading dock is present no off-street loading/ unloading spaces are required on-site.
Building material sales Garden material sales Furniture and floor covering sales Industrial Services and Manufacturing Light Vehicle sales, rental, storage, repair, or service Heavy vehicle and equipment sales, rental, storage, repair, or service Wholesaling	
Bus and Truck Terminals	Space sufficient to accommodate the maximum number of buses or trucks to be stored or loading/unloading at the terminal at any one time

- (3) Design and Use of Off-Street Loading Areas.
 - (i) Off-street loading space shall be located on the same lot occupied by the use served and shall be accessible from a public street or alley.

- (ii) Off-street loading space shall not be occupied by or considered as any part of the required off-street parking areas.
- (iii) No portion of an off-street loading space shall be located within any fire lane required by City ordinance or within aisles, driveways, or maneuvering areas necessary to provide reasonable access to any parking space.
- (iv) Off-street loading space and the aisles or driveways leading to the off-street loading space shall not be used for the sale, repair, dismantling, or servicing of any vehicles, or equipment.
- (v) Any off-street loading area located within one hundred (100) feet of the boundary of a residential District shall be screened from view from the District by a masonry wall at least eight (8) feet in height of a color matching one of the primary colors used on the primary façade of the building.

(4) M-DT District.

In the M-DT District (Section 29-4.2), the Director may alter or waive the requirements of this Section 29-4.3(j) (Off-street Loading Requirements) on a case-by-case basis if the applicant demonstrates that a specific standard is impractical or meaningless to achieve due to:

- (i) Existence of historic buildings in areas where loading would need to be located;
- (ii) Section 29-4.2 requirements that a building occupy the space where loading would need to be located; or
- (iii) Other site limitations or circumstances that make strict adherence to these standards impracticable.

29-4.3(k) - Bicycle Facilities.

Any parking lot or structure containing ten (10) or more parking spaces shall provide adequate and safe on-site bicycle parking facilities in accordance with the following standards:

- (1) Required Bicycle Spaces.
 - (i) Bicycle parking facilities shall be designed to accommodate the number of bicycle parking spaces, based on vehicle spaces, set forth in Table 4.3-6 below:

Table 4.3-6: Required Bicycle Parking Spaces	
Vehicle Spaces	Required Bicycle Spaces
10 – 50	4
51 – 99	8
100 – 199	12
200 – 299	15
300 or more	5 percent of the number of vehicle spaces or 50 space, whichever is less

- (ii) For parking lots required by other provisions of this Chapter to have more than twenty-five (25) vehicle parking spaces, the required number of vehicle parking spaces may be reduced by one (1) space for each required bicycle parking space installed.

(2) Design.

(i) Location.

Bicycle parking facilities shall be:

- (A) Located within fifty (50) feet of the main customer and employee entrances to the principle use provided such location does not impede ADA required access or compromise pedestrian or customer safety;
- (B) Clearly designated or of standard bicycle rack design which does not require separate identification;
- (C) Safely separated from vehicle maneuvering areas, and
- (D) Located on the ground level when in a parking structure.

(ii) Minimum Dimensional Standards.

Each bicycle parking space shall be at least:

- (A) Six (6) feet long;
- (B) Two (2) feet wide;
- (C) Have a minimum overhead clearance of seven (7) feet; and
- (D) If more than one (1) bicycle rack is used, a minimum five (5) foot wide access aisle is required beside or between each row of bicycle racks.

(iii) Materials.

Bicycle parking facilities shall be surfaced with all-weather material and maintained in a safe and well-maintained condition.

(iv) Security.

Bicycle parking facilities shall be equipped with either a lockable enclosure (bicycle locker) or a permanent, secure, and stationary structure (bicycle rack) that supports the bicycle frame and to which the frame and both bicycle wheels can be locked (with removal of the front wheel) or where the frame and one (1) wheel can be locked (if both wheels remain on the bicycle).

29-4.3(l) - Screening and Landscaping.

All parking facilities shall comply with the screening and landscaping requirements of Section 29.4-4 and 29-4.7.

29-4.3(m) - Permits and Certification.

- (1) Parking lots without an associated building permit shall be subject to separate permitting and inspecting during construction, as appropriate, and shall not be open for use until a certificate of occupancy has been issued by the Department.

- (2) Prior to authorizing use of any parking area established under this Section, or issuance of occupancy certificates for any uses dependent thereon, the Director shall inspect and certify the parking area to be in compliance with these standards.

29-4.3(n) - Delayed Construction of Required Parking.

Upon application of the owner, up to twenty (20) percent of the parking required under this Section may remain unimproved until such time as the Director finds that it must be improved to adequately serve the parking demand. The Director may approve a delayed construction of required parking if all of the following requirements are met:

- (1) The initial occupancy of the premises will be adequately served by the lesser number of spaces;
- (2) A site plan clearly indicating the location, pattern, and circulation to and from the deferred parking spaces is approved;
- (3) The land area delineated for future parking is brought to finished grade and is landscaped;
- (4) The land area delineated for future parking shall not be used for building, storage, loading or other purposes; and
- (5) The land area delineated for future parking shall not count toward the required landscaping for the site.

29-4.4 Landscaping, Screening, and Tree Preservation.**29-4.4(a) – Purpose.**

The purpose and intent of this section is to:

- (1) Establish healthy environmental conditions by providing shade, air purification, oxygen regeneration, groundwater recharge, storm water runoff retardation, erosion control, and noise, glare and heat abatement;
- (2) Provide visual buffering from streets, to buffer potentially incompatible land uses and to generally enhance the quality and appearance of a development site, and the City in total;
- (3) Encourage the preservation of existing trees and vegetation;
- (4) Supplement the land disturbance permit requirements of Chapter 12A; and
- (5) Protect trees and vegetation that offer environmental, aesthetic, habitat, sustainability, and economic benefits to the City and its citizens.

29-4.4(b) – Applicability.

- (1) Unless otherwise provided in this Section, the provisions of this Section 29-4.4 shall apply to lots and parcels in any District in which one or more of the following occurs:
 - (i) A new principal structure is constructed;

- (ii) The floor area in an existing principal structure is increased by more than twenty-five (25) percent;
 - (iii) An existing principal structure is relocated on the lot or parcel;
 - (iv) The principal structure is renovated or redeveloped (including but not limited to reconstruction after fire, flood, or other damage) for a use no more intense than existing previously, and the building footprint is increased by more than ten (10) percent;
 - (v) A new primary use parking lot containing ten (10) or more spaces is constructed; or
 - (vi) An existing primary use parking lot containing twenty-five (25) or more spaces is reconstructed or redesigned with significant changes of ten percent (10%) or greater, including, but not limited to the layout, location, or orientation of parking spaces, driving aisles or access drives.
- (2) Notwithstanding paragraph (1) above, lots or parcels having single-family attached, single-family detached, two-family residential, or live work use(s) or zoning shall be exempt from the General Provisions (Section 29-4.4(c)), and Property Edge Buffering (Section 29-4.4(e)) requirements of this Section.
- (3) The provisions of Section 29-4.4(g) apply to all development or redevelopment on lots and parcels that contain more than ten thousand (10,000) square feet of lot area, and to any new lot of record created after the Effective Date of this ordinance, regardless of the primary use of the property, in any District, except single-family or two-family residential structures on platted lots less than one (1) acre in size.
- (4) No provision of this Section 29-4.4 shall require landscaping to be installed, or a tree to be preserved, in a portion of a lot required to be occupied by a building pursuant to the Building Form Standards in Section 29-4.2 (M-DT District). If there is a conflict between the requirements of Section 29-4.2 and the requirements of this Section 29-4.4, the Director may modify or waive the provisions of this Section 29-4.4 to allow the requirements of Section 29-4.2 to be met.

29-4.4(c) - General Provisions.

(1) Landscape Plan Required.

A landscaping plan, prepared in accordance with this Section, shall be required as part of all applications for development or redevelopment, unless otherwise exempt per this Chapter. Approval of a landscape plan shall be required prior to the issuance of a building permit, land disturbance permit, and prior to the development of any parking area or loading/ unloading area and may be combined with other required application material. Landscaping plans may be amended, however new plans shall be submitted for review and approval prior to installation of plant material, and in all cases must comply with the current landscaping requirements of this Chapter.

The landscape plan shall be presented on its own page, designed to scale, signed by an International Certified Arborist or design professional and contain the following information:

- (i) A Tree Preservation Plan that includes the following elements as described below:
 - (A) The full area of any climax forest on the site.
 - (B) The twenty-five (25) percent of climax forest to be saved on parcels greater than one (1) acre in size. Such preservation areas shall be depicted as specified in item “D”, below, and shall not include trees, located within a stream buffer, right-of-way or utility easement.
 - (C) Areas may be determined by actual field measurement, by planimeter, or automated software. (See Section 29-4.4(i) for climax forest preservation requirements.).
 - (D) The required twenty-five (25) percent of climax forest to be preserved on any tract of land -shall remain as an undeveloped stand of timber and comply with the following:
 - 1) Required preservation areas shall be platted as a common lot that is subject to a Tree Preservation Easement. The required platting of a common lot shall not apply to preservation areas within non-residential development; however, such preservation area shall be subject to a Tree Preservation Easement;
 - 2) When required preservation is greater than thirty thousand (30,000) square feet an applicant may divide such preservation area provided no single area contains less than thirty thousand (30,000) square feet. Division of preservation area is permitted in accordance with the standards shown in Table 4.4-1.
 - 3) When the tract of land includes a stream buffer none of the trees located within the stream buffer may be counted for meeting the required preservation. Trees retained will count toward screening requirements contained in Section 29-4.4 (Landscaping and Screening).
 - 4) An adjustment in the standards of Table 4.4-1 may be considered by the Board as a variance subject to the provisions of Article 6 of this Chapter.

Table 4.4-1: Climax Forest Division		
Required area to be preserved (in sq.ft.)	Minimum parcel size (in sq.ft.)^[1]	Maximum number of parcels
60,000	30,000	2
120,000	30,000	2
240,000	30,000	2
480,000	30,000	3
Greater than 480,000	180,000	Unlimited

Notes:

[1] – No parcel created shall have less than the minimum area specified

- (ii) A planting schedule detail containing common and botanical plant names, sizes, and graphical depictions.
- (iii) The size and location of any walls, earth berms, and fences.

- (iv) Provisions for watering, soil stabilization, plant protection, and maintenance.
- (v) Location and description of any barriers to be erected to protect any vegetation from damage both during and after construction.
- (vi) Zoning for the proposed development and adjacent properties.
- (vii) Calculations showing compliance with this Section 29-4.4.
- (viii) The methods used to remove trees, the areas of tree removal, and areas of trees being saved and showing the location of protective fencing. The areas to be preserved shall be shown on the plan along with State Plane Coordinates at all points of intersect.
- (ix) Aerial photograph conducted within one (1) year of the application submittal date, or if no such aerial photography is available to the applicant, then an image from a public source such as Google Earth showing clearing limits, preservation area, protective fencing, and topography may be utilized as an alternative.
- (x) Any land annexed or within the City of Columbia corporate limits that did not follow the tree preservation provisions of this Chapter and is sought to be redeveloped or subdivided shall be subject to the following:
 - (A) No permit for the purpose of allowing redevelopment or subdivision shall be issued for a period of six (6) years unless the provisions of subsection (B), below, have been met.
 - (B) To obtain relief from the permitting restriction specified in subsection (A), above, the following shall be met:
 - 1) The subject property shall be reforested such that the required twenty-five (25) percent of the climax forest that should have been preserved is re-established on a designated common lot. If required preservation is greater than thirty thousand (30,000) square feet, multiple common lots may be established in accordance with the provisions of Table 4.4-1.
 - 2) In addition to the reforestation requirements indicated in subsection (B)1) above, any annexed tract containing a regulated stream for which a stream buffer would have been required and no longer exists shall be reforested with native plant species at the reforested rate as shown below. The reforested stream buffer shall not be credited towards meeting the twenty-five (25) percent of the climax forest required by subsection (B)1) above.
 - 3) Reforested common lots shall meet the following coverage standards:
 - (a) Fifty (50) percent of the area shall be covered with the following types of trees. No more than fifty (50) percent of the trees used to meet this requirement may be the same size.
 - (i) Tree whips between one (1) to three (3) feet height at planting;
 - (ii) Tree saplings between four (4) to seven (7) feet in height at planting;
 - (iii) Container or root bag trees one-half ($\frac{1}{2}$) inch to one and one-half ($1\frac{1}{2}$) - inch caliper trunk size measured six (6) inches off the ground.
 - (b) Fifty (50) percent of the area shall be covered by shrubs that are one (1) to three (3) feet in height at planting.

- (c) One hundred (100) percent of the area shall be covered in native grasses and Forbes seed mix that includes: Indian grass, Big Bluestem, Coreopsis, Tick seed, Prairie Partridge Pea, Illinois Bundle Flower, and Purple Prairie Clover.
- (d) Coverage and spacing of required reforestation plant materials shall comply with the requirements set forth in Table 4.4-2.
- (C) A “look-back” period of three (3) years shall be used to determine the required area of climax forest that should have been preserved on the property. Such analysis will be conducted using aerial photography.
- (D) Any climax forest preserved on the site that is located within a regulated preservation area (i.e. a stream buffer) shall not be counted toward meeting the required twenty-five (25) percent preservation standards or as part of the required area to meet reforestation. If climax forest has been preserved outside of a regulated preservation area the amount preserved may be counted to off-set that area which would otherwise be required to be reforested.

Table 4.4-2: Reforestation Plant Material Coverage and Spacing		
Plant Type	Coverage Area	Plant Spacing Range
Tree Whip	135 sq. ft.	15-30 ft.
Tree Sapling	270 sq. ft.	20-40 ft.
Container Tree	540 sq. ft.	30-40 ft.
Root Bag Tree	600 sq. ft.	30-40 ft.
Shrubs	75 sq. ft.	10-15 ft.
Grass or Flowering plugs	10 sq. ft.	5 ft.
Native Grass & Forbes	6 lbs of Pls/acre	Mixture to contain minimum 3 different native seeds of which no single one is greater than 50% of mix.

(2) Minimum Required Landscaping.

- (i) In the M-DT District (Section 29-4.2), the required “Private or Public Open Areas” must comply with the following standards:
 - (A) Any ground level required Private or Public Open Area shall have at least one (1) tree per eight hundred (800) square feet, which is at least two (2) inches DBH (diameter at breast height), and at least ten (10) feet in overall height.
 - (B) Where new trees are planted to meet this requirement, they shall be no closer than five (5) feet to any common lot line.
 - (C) Urban General lots that are reusing existing structures with no ground level Private or Public Open Area are exempt from this requirement.
- (ii) Unless otherwise provided in this section, in all other Districts, a minimum of fifteen (15) percent of the total land area of any tract, parcel or lot shall be landscaped. Landscaping

shall be installed to comply with the specific requirements for Street Frontage Landscaping, Property Edge Buffering, and Parking Lot Landscaping in this section 29-4.4, and the remainder (if any additional landscaping is needed to meet the fifteen (15) percent minimum) shall be reasonably distributed throughout the site.

(3) Plant Materials.

Plant materials shall be selected from the City's Guidelines for Landscaping and Screening or approved by City Arborist. All plant material shall be hardy to central Missouri (USDA hardiness Zone 5b), free of disease and insects, and must conform to the American Standard for Nursery Stock of the American Association of Nurserymen. No one (1) species for each plant type may comprise more than fifty (50) percent of the total for that plant type. Invasive species, as identified by the Missouri Department of Conservation's invasive species list, are prohibited. The use of plastic or other artificial plant materials is prohibited. Fifty (50) percent of all trees planted are required to be Large to Medium species and only thirty (30) percent of the Large to Medium trees can be of a single species.

(4) Minimum Living Materials.

In all areas where landscaping is required, a minimum of fifty (50) percent of the surface area shall be covered by living materials, rather than mulch, wood chips, bark, gravel, peat moss, or other non-living materials.

(5) Grading and Drainage.

All open areas shall be graded, properly drained, and maintained to encourage on-site water retention and percolation while minimizing ponding or standing water for periods of more than three (3) days.

(6) Minimum Plant Sizes.

The minimum planting sizes for planting materials, at time of planting, shall be as set forth in Table 4.4-3 and in the City's Guidelines for Landscaping and Screening:

Table 4.4-3: Minimum Plant Sizes	
Plant Type	Minimum Size
Large Deciduous Shade Tree – mature height greater than 45 ft.	Two inch caliper, measured six inches above the ground, as specified by the American Association of Nurserymen.
Medium Deciduous Shade Tree – mature height 30-45 ft.	Two inch caliper, measured six inches above the ground, as specified by the American Association of Nurserymen.
Small Deciduous Shade Tree – mature height 20-30 ft.	As specified by the American Association of Nurserymen, except for true dwarf species.
Ornamental Tree – mature height less than 20 ft.	Four feet in height, as specified by the American Association of Nurserymen, except for true dwarf species
Conifers	Six feet in height
Shrubs	Five gallon container size

Ground Cover Plants (crowns, plugs, containers)	A species appropriate number to provide 50% surface coverage after two growing seasons
Grass Seeding or Sod	Seed mix shall be at least eighty percent pure live seed and 99% weed free.

(7) Plant Material Spacing.

- (i) In the M-DT District (Section 29-4.2), plant material spacing shall comply with this Section and with the requirements of Section 29-4.20 (Urban Space Standards).
- (ii) In all other Districts, plant materials shall not be placed closer than four (4) feet from any fence line or property line unless required to comply with the provisions of subsection 29-4.4(e) (Property Edge Buffering). Where tree planting requirements are based on linear street frontage, areas occupied by driveways shall be included when calculating the number of trees required to be planted, and any trees that would otherwise be required in driveways shall be planted in other landscaped front yard areas unless prohibited by minimum spacing requirements for that species.

(8) Snow Storage Areas.

Areas required for snow storage and areas required for landscaping shall not overlap, except that snow may be stored on ground cover landscape areas (e.g., turf) that do not contain required landscape trees or other plantings.

(9) Screening of Outdoor Storage Areas.

All exterior storage areas that are expanded or established following adoption of this Chapter, except those on single- and two-family lots, shall be enclosed by a permanent screen at least eight (8) feet in height above the ground surface of the storage area, or of such additional height as necessary to screen the stored materials from public view, but non-vegetative screening materials shall not exceed a maximum height of twelve (12) feet. The required screening shall have a year round opacity of at least eighty (80) percent, and if landscaping is used, the eighty (80) percent opacity shall be achieved within four (4) full growing seasons. When a solid wall or any solid fence is used for screening, ornamental landscaping shall be placed between the fence and the adjacent property lines.

(10) Screening of Rooftop Mechanical Equipment.

In all R-MF and Mixed Use Districts, rooftop mechanical equipment and appurtenances other than solar collectors located on the principal structure shall be screened on all sides with a structure equal to or exceeding the height of the mechanical equipment or appurtenance, measured from the rooftop. Screening enclosures shall use at least one of the predominant materials used in the façades of the principal structure and one of the predominant colors used in the principal structure.

(11) Vision Clearance.

Landscaping and screening shall not be allowed to obstruct the view of motorists using any street, private driveway, parking aisles or the approach to any street intersection so as to constitute a traffic hazard or condition dangerous to the public safety upon any such street.

(12) City Right-of-Way.

Tree selection, planting, removal, or pruning, in City rights-of-way and easements shall be in compliance with Chapter 24, Article V of the City Code or with approval from the City Arborist.

(13) Installation Due to Season.

- (i) Landscaping of the site shall be completed within one (1) planting season (spring to fall) of the completion of the exterior of the building, in accordance with building permit requirements.
- (ii) All landscaping work must be completed prior to the final inspection of a building or within one (1) year of issuance of the land disturbance permit, whichever occurs later. If completion of the work or building is at such time of the year that the landscaping cannot be completed, a performance bond, escrow, letter of credit, or other acceptable financial instrument for completion of the work may be accepted by the Director to allow the issuance of a certificate of occupancy.

29-4.4(d) - Street Frontage Landscaping.**(1) Landscaping Strip Within Private Yards.**

All paved areas with more than forty (40) feet of length within twenty-five (25) feet of a street right-of-way shall have at least a six (6) foot wide landscaped buffer which shall be improved in accordance with the provisions of Section 29-4.4(e)(2) within private yards separating parking areas from abutting street right-of-way.

(2) Street Trees.

Street tree landscaping shall be installed as follows and in accordance with Chapter 24, Article V of the City Code:

- (i) One (1) tree per forty (40) feet of street frontage.
- (ii) Thirty (30) percent of the trees shall be large trees and thirty (30) percent shall be medium trees.
- (iii) No more than thirty (30) percent of required trees may be from one (1) tree species.
- (iv) The medium and large trees shall be planted at least forty (40) feet on center.
- (v) Street trees may be clustered and placed at uneven intervals, with approval from the City Arborist.
- (vi) If the public right-of-way does not contain or accommodate street trees meeting this requirement, then the property owner must install the required street trees within the private landscaping buffer.
- (vii) Street trees may not be counted towards compliance with all other provisions of Section 29-4.4.

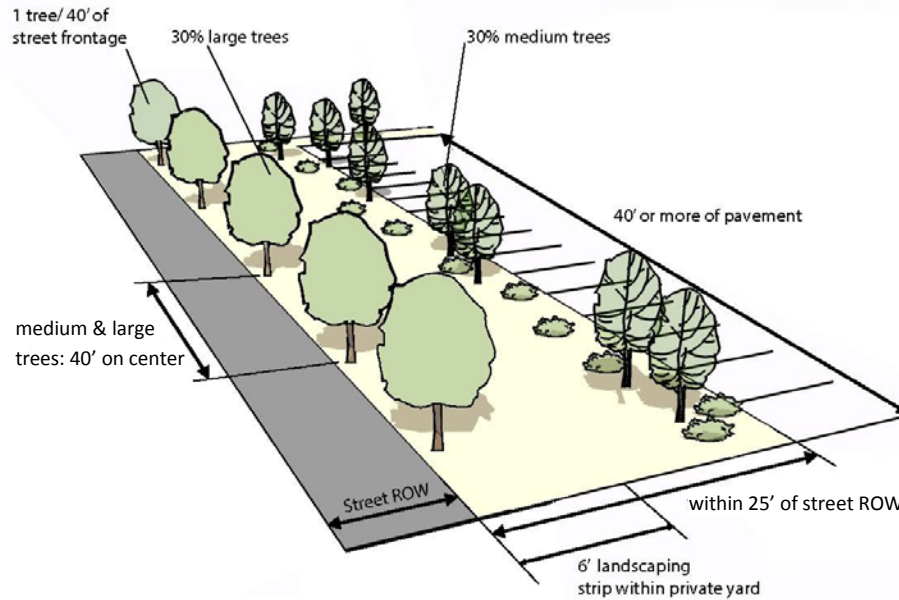

Figure 4.44-1: Street Trees

(3) Driveways.

Street frontage landscaping may contain driveways.

(4) Attached or Detached Residences.

Lots that contain detached or attached residences and which have side or rear property boundaries abutting collector or arterial street right-of-way shall have screening either along such boundaries or around any patios on the lot which are visible from the right-of-way. The screening shall consist of landscape materials, ornamental fences or walls in combination with plant materials, properly stabilized earthen berms, or a combination of these methods. Screening shall be so designed that at least fifty (50) percent opacity is achieved, viewed horizontally, in the space between one foot and five feet above grade at the screening line, at the time of installation; provided that where plant materials are used for screening, these shall be selected and placed to achieve the same objective within four full growing seasons following planting. Screening shall be placed on private property. All screening material, including plant material, shall be continuously maintained in good condition to the above standards.

(5) Sight Triangle.

Except in the M-DT District (Section 29-4.2), on any corner space or lot on which a front or side yard is required, no wall, fence, sign, or other structure or no plant growth of a type within a sight triangle which would interfere with traffic visibility, in accordance with City policy based on the Missouri Department of Transportation's Engineering Policy Guide provided plant material reaching no more than three (3) feet or higher at maturity will be allowed.

29-4.4(e) - Property Edge Buffering.

(1) Buffering Required.

Where a property contains at least ten thousand (10,000) square feet of area or more than one thousand five hundred (1,500) square feet of paved area or any vehicle loading/unloading areas, buffering shall be installed as required by Table 4.4-4.

- (i) To use this table, an applicant identifies the proposed use of the property in Row 3, across the top of the table, and then reads down Column 2 to identify the zoning or use of the adjacent property along each property line. The box at the intersection of Column 2 and Row 3 identifies the screening and buffering requirement for the applicant on that property line. Different types of screening and buffering may be required on different property lines, as indicated in Table 4.4-4.
- (ii) Transitional screening shall not be required for urban agriculture and farmer’s markets.

Table 4.4-4: Transitional Screening and Buffering											
Use of Subject Property											
Use of Adjacent Properties	Adjacent Zone District	Applicant’s Use	Single & Two-Family		Multi-Family		Mixed-Use		Commercial		Industrial
	Zone District	Structure Type	Res.	Non-Res.	Res.	Non-Res.	Vert.	Horiz.	1-3 Stories	3+ Stories	--
	Single & Two-Family	Residential	0	2	1	2	3	3	3	3	3
		Non-Residential	0	0	2	1	1	1	1	2	
	Multi-Family	Residential	0	2	0	2	2	2	3	3	3
		Non-Residential	0	0	1	0	1	1	1	2	
	Mixed-Use	Vertical	0	1	2	1	0	0	1	2	3
		Horizontal	0	1	2	1	0	0	0	1	
	Commercial	1-3 Stories	0	1	3	1	1	0	0	1	3
		3+ Stories	0	0	3	2	2	1	0	0	3
Industrial	--	0	0	3	3	3	3	3	3	0	

Level 0 does not require a screen or landscape buffer.
 Level 1 requires a six foot wide landscape buffer.
 Level 2 requires a four-foot wide landscape buffer and a six foot tall screening device.
 Level 3 requires a 10-foot wide landscape buffer and an eight-foot tall screening device.

- (iii) Where a residential use has been established on a parcel that is zoned for mixed use or commercial and the adjacent property is proposed to be developed or redeveloped with a non-residential use screening and buffering shall be installed on the developing or redeveloping parcel as defined in Table 4.4-4.
- (iv) Where a residential use is constructed on a parcel that is zoned for mixed use or commercial following the development of an adjacent parcel with a non-residential use, the adjacent non-residentially improved parcel shall not be required to install the

screening or buffering shown in Table 4-4.4 until they are redeveloped or expanded by more than twenty-five (25) percent.

(2) Landscape Buffer Location and Design.

- (i) The required landscape buffer shall be installed on the applicant’s side of the screening device.
- (ii) It shall be designed so that at least eighty (80) percent opacity is achieved, viewed horizontally, in the space between one (1) foot and five (5) feet above grade at the screen line, at the time of installation.
- (iii) The landscape buffer shall include the following plant mix:
 - (A) Four (4) of the categories of planting material contained in Section 29-4.4(c)(6) and the Guidelines for Landscaping and Screening, or as approved by the City Arborist;
 - (B) One (1) tree with a two (2) inch caliper that is ten (10) feet in height at the time of installation for each two hundred (200) square feet of buffer area, and
 - (C) Shrubs and flowering plants that cover a minimum of fifty (50) percent of the remaining area with a minimum of twenty-five (25) percent of that plant material being in flowering shrubs.

(3) Screen Location and Design.

- (i) The screen shall be located along the property line of the applicant’s lot, and shall not extend into the established setback of the adjoining lot.
- (ii) The screen shall be constructed of wood, masonry, brick, stone, wrought iron, compact evergreen hedging, an earth berm, or some combination of those materials. Chain link fence and railroad ties are prohibited.
- (iii) The combined height of the screening methods identified in this subsection shall not be less than six (6) feet.

29-4.4(f) - Parking Area Landscaping.

- (1) All parking areas containing over one hundred (100) parking spaces shall include interior landscaping equal to at least ten (10) percent of the paved area. Landscaping required to meet the requirements of sections 29-4.4(d) (Street Frontage Landscaping) or 29-4.4(e) (Property Edge Buffering) above shall not be used to satisfy this requirement.

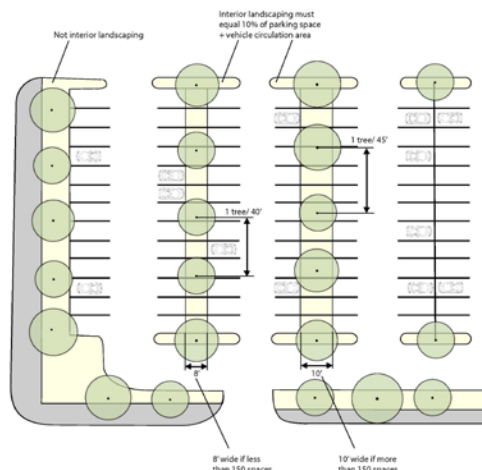

Figure 4.4-2: Interior Parking Area

- (2) Interior landscaped areas to meet the requirements of subsection (1) above shall be at least ten (10) feet in width, shall contain at least (1) one tree per forty (40) lineal feet of interior landscaped area or part thereof, and shall be designed lower than the paved area so that storm water from the paved parking areas shall flow into the landscaped areas. If curbs are used to prevent vehicle entry into these lowered landscaped areas, they shall have breaks to permit stormwater to enter the landscaped areas.

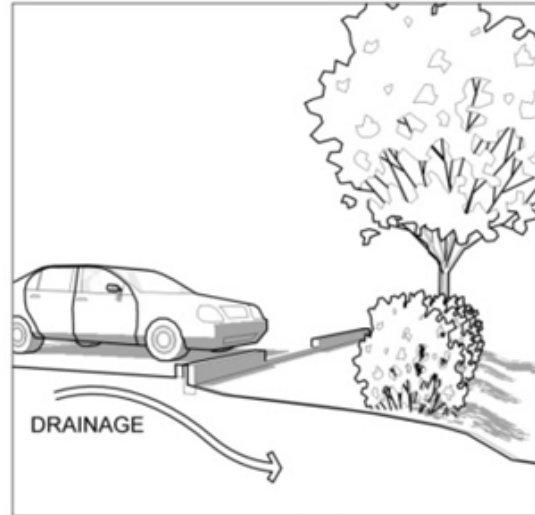

Figure 4.4-3: Parking Area Curb Breaks

- (3) No parking areas shall contain more than one hundred fifty (150) spaces unless it is separated by a landscaped area of at least ten (10) feet in width from other areas containing parking spaces. The ten (10) foot wide landscaped area shall contain four (4) of the categories of planting materials listed in Section 29-4.4(c)(6). In addition, trees shall be planted within the ten (10) foot wide landscaped area at the rate of one tree for each forty (40) lineal feet. Appropriately placed connections between parking areas are permitted.

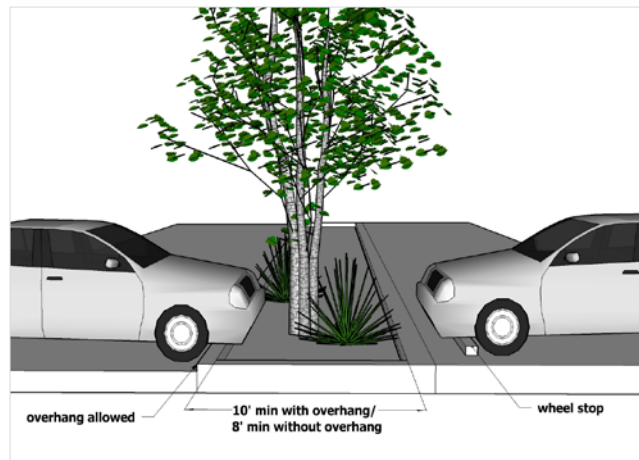

Figure 4.4-4: Interior Landscaped Area

- (4) In addition to the above, paved areas developed after August 19, 1991, exceeding four thousand (4,000) square feet in area, and additions exceeding four thousand (4,000) square feet in area to paved areas that were developed prior to August 19, 1991, shall contain a minimum of one (1) tree within a growspace/island of at least 170 square feet within the interior for every four thousand (4,000) square feet of paved area. For every additional tree planted within the interior of a paved area required parking may be reduced by three (3) parking spaces. For every additional tree planted within a perimeter bump/bulb-out containing one hundred fifty (150) square feet required parking may be reduced by two (2) parking spaces.

If there is no area on the site where required trees can be installed so that they do not interfere with the loading and unloading of large vehicles, the required trees may be placed at the perimeter of the paved areas or in other suitable locations on the site.

- (5) Of the combined total number of trees required to be planted in the interior parking lot, no less than thirty (30) percent shall be of a species of medium shade trees, and no less than forty (40) percent shall be of a species of large shade trees, no single tree species shall make up more than forty (40) percent of the trees required to be planted in the interior of the parking area.

29-4.4(g) - Preservation of Existing Landscaping.

(1) Applicability.

The standards of this subsection shall apply to all development and redevelopment on lots or parcels equal or greater than ten thousand (10,000) square feet in area and to all subdivisions approved after the Effective Date of this Chapter. These standards do not apply to the construction of a single-family detached, single-family attached, or two-family residential structure. (See also Section 29-4.4(i) (Clearing of Trees) for additional standards related to tree removal.)

(2) Credit for Preserving Existing Mature/Significant Trees.

Applicants that preserve mature, healthy trees as part of development or redevelopment may obtain credits toward trees required by this Chapter including, but not limited to, street frontage, landscaping, and edge buffering. To obtain credit, the preserved trees must be on the same lot, at least five (5) inches in diameter breast height (DBH), and must be in healthy condition as determined by the City, and be part of the approved tree protection detail.

Credit is not given for shrubs, or trees preserved as part of a stream buffer, tree preservation, or otherwise undevelopable area. Credit for preserved trees shall be granted as shown in Table 4.4-5 and may be applied to reduce the number of trees required to be installed pursuant to this Section 29-4.4. Trees contained in an existing or proposed utility or other easement cannot be credited toward required tree preservation, screening, or landscaping requirements.

Any preserved trees for which credit is given, and that are lost to damage or disease within two (2) years after the credit is awarded, shall be replaced by the property owner within six (6) months at a ratio of one (1) tree per one (1) inch of DBH lost. Replacement trees must be at least two (2) inch in caliper size. Other plantings that die within eighteen (18) months of preservation credit received shall be replaced in kind within six (6) months.

Table 4.4-5: Tree Preservation Credits	
Caliper of Preserved Tree (in.)	Reduction in Number of Required Trees
Over 12 in. DBH	3
Over 8 in. to 12 in. DBH	2
5 in. to 8 in. DBH	1

(3) Significant Trees.

- (i) Twenty-five (25) percent of significant trees shall be preserved during development or redevelopment. All vacant and undeveloped land and all property to be redeveloped, including additions and alterations that require a land disturbance permit, shall abide by this section. A “significant tree” means a tree that is not diseased, dying, or of a noxious invasive species and that is at least twenty (20) inches diameter at breast height (DBH) for a deciduous tree that is located outside of the Tree Preservation and Stream buffer or utility easement.
- (ii) When a significant tree is removed, the property owner shall replace such tree(s) on the lot as follows:
 - a. A significant deciduous tree that is removed shall be replaced by three (3) large to medium deciduous trees, each with a minimum size at planting of two (2) inches caliper.
 - b. A significant coniferous tree that is removed shall be replaced by two (2) coniferous trees, each with a minimum height at planting of eight (8) feet.
 - c. In lieu of planting replacement trees a payment of seven hundred fifty dollars (\$750.00) per tree can be paid to the City of Columbia right-of-way landscaping planting budget for planting of public street trees.
 - d. Replacement trees shall be maintained by the property owner for at least three (3) years.
- (iii) Exceptions.

Plants that create a public nuisance, as determined by the City Arborist, are not protected by the provision of this Section.

(4) Tree and Vegetation Protection During and After Construction.

- (i) Tree protection shall be required prior to and during site disturbance and construction activities. No activities with the potential of causing damage to the root systems of trees shall be allowed within twenty (20) feet outside the drip line of the trees being preserved, protected or planted as part of the landscaping or tree preservation plan.
- (ii) An orange construction fence or an equivalent shall be installed and “Tree Preservation – Keep Out” signs shall be posted every one hundred (100) feet along the perimeter of the tree preservation area, and the fencing and signs shall be maintained for the duration of all site disturbance and construction activities.
- (iii) If site grading occurs within twenty (20) feet of the Tree Preservation area, the perimeter of the area must be trenched to a minimum width of two (2) feet and a minimum depth of two (2) feet. Tree roots shall then be pruned by the property owner.
- (iv) The tree and vegetation protection fencing shall be clearly shown on the project approval documents. No construction, grading, equipment or material storage, or any other activity shall be allowed within the fenced area. All tree and vegetation protection measures shall be inspected and approved by the City Arborist prior to start of any land disturbing activities.

29-4.4(h) - Alternatives and Adjustments.

- (1) This section is not intended to prevent the use of a material or method of construction not prescribed specifically by this section, especially whenever a stream, natural rock formation or other physiographic condition exists; provided that any such alternate material or method has been approved in writing or in plan and its use authorized by the Director as providing at least equivalent quality, effectiveness, durability, hardness, and performance to the specific requirements of subsections 0 through (g) above.
- (2) The Director may modify the Property Edge Buffering standards of Section 29-4.4(e) by up to ten (10) percent (increase or decrease in width and height) if necessary to provide adequate buffering of impacts or to respond to specific site conditions.
- (3) The Director may modify the Property Edge Buffering standards of Section 29-4.4(e) if the Director determines that the design, height, location of uses, massing, and landscaping of the applicant's project mitigates potential adverse impacts on surrounding properties.
- (4) The Director may modify the Street Frontage Landscaping standards of Section 29-4.4(d) for properties involving outdoor sales of vehicles or equipment if the Director determines that strict application of these standards will significantly reduce visibility of the goods being sold from the fronting public street.
- (5) Where the requirements of this section are applied to a redevelopment or reconstruction project, rather than a new development, the Director may authorize a reduction of minimum off-street parking requirements established in Section 29-4.3, by up to ten (10) percent, if necessary to accommodate street frontage landscaping required by subsection 29-4.4(d) above or the parking area landscaping required by subsection 29-4.4(f) above.
- (6) Where the requirements of this Section 29-4.4 are applied to a redevelopment or reconstruction project, rather than a new development, the scope of compliance shall be commensurate with the scope of redevelopment.

29-4.4(i) - Clearing of Trees.

- (1) The mechanized clearing of trees, logging of trees or clear-cutting of trees by any means on tracts of land of one (1) acre or more shall be unlawful unless done in compliance with a land disturbance permit pursuant to Chapter 12A of the City Code.
- (2) A minimum of twenty-five (25) percent of any climax forest area on any tract of land, one (1) acre in size or greater, is subject to the land preservation standards shown in 29-4.4(c)(1)(i)(d). When the tract of land includes a stream buffer, none of the required tree/land preservation shall be within the stream buffer. Trees retained will count toward screening requirements contained in Section 24-4.4 (Landscaping and Screening).
- (3) When logging is to occur prior to approval of a tree preservation plan or on property not otherwise subject to land disturbance requirements, a logging plan demonstrating compliance with tree preservation requirements must be submitted to the City Arborist. This logging plan will include the area in square feet of forest land, the area in square feet of climax forest, and demonstrate that twenty-five (25) percent of the area of climax forest will be preserved after logging. Each logging operation on the same site will require a

separate land disturbance permit. Under no circumstance shall successive logging remove greater than seventy-five (75) percent of the climax forest present upon the site before logging.

- (4) An approved Tree Protection and Preservation Plan shall be required prior to issuance of a land disturbance permit and during the activities associated with the land disturbance permit in accordance with the administrative standards promulgated and enforced by the Director of Public Works, but under no circumstances shall activities with the potential of causing damage to the root systems of trees be allowed within the perimeter of the drip line of the trees being preserved, protected or planted as part of the landscaping plan.
- (5) Any land owner requesting annexation into the City shall abide by the tree preservation provisions of the City Code. Any land that did not follow the tree preservation provisions of the City Code shall wait five (5) years before they are able to obtain a permit for redevelopment or subdivision unless the provision of 29-4.4(c)(1)(x) have been met.

29-4.5 Exterior Lighting.

29-4.5(a) – Purpose.

The purpose of this Section 29-4.5 is to enhance the attractiveness and livability of the community for its citizens, both during the day and at night without compromising the safety, security, and well-being of persons engaged in outdoor nighttime activities. It is the intent of this section to control the obtrusive aspects of excessive and careless outdoor lighting usage while preserving, protecting, and enhancing the lawful nighttime use and enjoyment of property. Intended outcomes include:

- (1) Insuring that parking areas, public gathering places, approaches to buildings, and other areas active at night have adequate outdoor illumination.
- (2) Minimizing the adverse impacts on public safety and comfort due to excessive glare.
- (3) Providing minimum and maximum light levels and establishing standards of lighting uniformity to enhance night vision and security.
- (4) Minimizing spillage of light on adjacent or nearby property.
- (5) Minimizing the effects of skyglow.
- (6) Encouraging energy conservation through the use of efficient lighting technologies.

29-4.5(b) - IESNA Standards and Interpretations.

The standards in this Section 29-4.5 are based on the standards in the IESNA Lighting Handbook, 9th Edition and "Lighting for Exterior Environments: An IESNA Recommended Practice," RP-33-99 both published by the Illuminating Engineering Society of North America. These publications shall be used in interpreting undefined terms and unclear provisions of this section. When new editions of these publications are available, the Environment and Energy Commission shall prepare a report to the Council setting forth any recommended changes in the standards of this section.

29-4.5(c) - Conformance with Applicable Codes

All outdoor illuminating devices shall be installed in conformance with the provisions of this Section 29-4.5, the building code, the electrical code and Section 29-4.8 (Sign Standards), as applicable and under appropriate permit and inspection.

29-4.5(d) - General Standards and Exceptions.

- (1) This section applies to all new construction that includes outdoor lighting and to all replacement of outdoor lighting structures other than replacement of lighting fixtures, except that:
 - (i) Lighting structures installed lawfully before December 4, 2006, may continue in operation. Routine replacement and repair of lighting fixtures installed before December 4, 2006, shall be exempt from the requirements of this section.
 - (ii) Lighting installations in the M-BP or PD Districts shown on development plans approved before December 4, 2006, shall comply with outdoor lighting standards adopted as part of those plans.
 - (iii) Additions to buildings, parking lots, and other site improvements approved before December 4, 2006, shall be exempt from the lighting plan submittal requirements of subsection (f) below, provided the addition does not increase either the size of a building or parking lot greater than fifty (50) percent of its existing gross floor area.
 - (iv) The addition of individual lighting structures shall not require submittal of a lighting plan pursuant to subsection (f) below provided the owner provides a certification that the additional lighting structures conform to the design criteria of this section, or the property owner obtains a special exception as provided in section 29-6.3(f).
 - (v) This section shall not apply to public street lighting.
 - (vi) Seasonal decorations that include illuminated displays are exempt from this section except that no light fixture that is part of a seasonal display shall be aimed or directed to create glare or light spillage.
 - (vii) This section shall not apply to the installation of an outdoor lighting structure if an application for a building permit involving the installation of that structure was received by the City on or before December 4, 2006.
- (2) All outdoor facilities intended for nighttime use (5:00 p.m. – 7:00 a.m.) shall be illuminated and such illumination shall be maintained in compliance with the standards of this section.
- (3) Searchlights and similar spot light fixtures, such as moving, flashing, chasing and strobe lights used to attract attention to a place are prohibited.
- (4) For enhanced security, only light sources with a color rendering index (CRI) of greater than sixty (60) shall be used. See Table 4.5-1 for CRI range of lamps.
- (5) Any light source or lamp that emits more than 900 lumens (13 watt compact fluorescent or 60 watt incandescent) shall be concealed or shielded with an IESNA full cut-off style fixture with an angle not exceeding 90 degrees to minimize the potential for glare and unnecessary diffusion on adjacent property.

Table 4.5-1: Color Rendering Index Range of Lamps	
Lamp Type	Color Rendering Index (CRI)
Fluorescent	
Lite White	> 40
Warm White	> 50
Warm White Deluxe	> 70
Cool White	> 60
Cool White Deluxe	> 80
White	> 60
Daylight	> 70
T12 Rare Earth Phosphor	> 69 to > 80
T8 Rare Earth Phosphor	> 70 to > 90
Natural	> 80
Incandescent	> 80
Compact T4, T5	> 80
C50, C70, DSGN 50	> 90
Mercury Vapor	
Clear	15 - 25
Coated	40 to > 50
Metal Halide	
Clear or Coated	60 > 90
High Pressure Sodium	
Standard	> 20
Color Improved	> 60
High Color Rendering	> 80
Low Pressure Sodium	> 20
From "Lighting for Parking Facilities," Report 20 - 98 of the IESNA 1998. For lamp types not listed above, the Manufacture's CRI for the lamp can be used to determine if the lamp meets the standard of a CRI > 60.	

29-4.5(e) - Methods of Measurement.

- (1) Unless otherwise specified, all footcandle values shall be measured horizontally and shall refer to maintained footcandles (initial values with a light loss ratio applied).
- (2) Light spillage thresholds shall be determined by horizontal footcandles measured at ground level at the property line.
- (3) Maximum height shall be measured as the vertical distance between the finished grade directly below a light fixture and the highest point on the light fixture.
- (4) A light loss ratio of seventy-two tenths (0.72) shall be used to calculate lighting plans.

- (5) Maximum-to-minimum is the highest horizontal illuminance point divided by the lowest horizontal illuminance point or area and should not be greater than the values shown.

29-4.5(f) - Photometric Lighting Plan Requirements.

All applications for building permits involving installation of outdoor lighting shall include the following information:

- (1) A photometric plan, prepared by a lighting engineer at a scale of no smaller than one (1) inch equals sixty (60) feet which consists of:
 - (i) An accurate site plan of the proposed development indicating the location of property lines, and all existing and proposed land improvements including but not limited to buildings, parking lots, aisles and driveways, streets, walkways, landscaped areas and accessory structures;
 - (ii) The estimated footcandles at ground level across the entire site, at minimum intervals of thirty (30) feet, including estimated footcandles at the property line;
 - (iii) Location and type of all lighting fixtures;
 - (iv) A table indicating the type, light source, wattage, output in lumens, light loss ratio, height of luminaires above grade and the maximum-to-minimum ratio. The maximum-to-minimum ratio shall be calculated using ninety-five (95) percent of the data point sources, excluding two and one-half (2.5) percent of the lowest values and two and one-half (2.5) percent of the highest values; and
 - (v) A certification by a lighting engineer that the lighting plan complies with the standards of this section. The Director may rely on this certification for issuance of appropriate construction and occupancy permits.
- (2) Manufacturer's catalogue specifications of all luminaires to be used, indicating the design, refractor (lens) type, cutoff angle (full, semi or non-cutoff), and any special features affecting the performance of the light.

29-4.5(g) - Parking Lot Lighting.

The following standards apply to the illumination of parking lots:

- (1) Minimum Lighting and Maximum Illuminance.
 - (i) During business hours, parking lots shall be uniformly illuminated such that vehicular license plates, addresses and directional, instructional or regulatory signs are plainly visible without blind spots or excessive distortion of color.
 - (ii) The maximum footcandles allowed on adjacent property is one-half (0.5) for residential and two (2) for non-residential, and maximum illuminance shall comply with Table 4.5-2.

Table 4.5-2: Maintained Illuminance Values for Parking Lots		
	Basic (footcandles)	Enhanced Security (footcandles)
Minimum horizontal illuminance	0.2 footcandles	0.5 footcandles
Maximum-to-minimum ratio	20:1	15:1
Minimum vertical illuminance	0.1 footcandles	0.25 footcandles
From "Lighting for Parking Facilities," IESNA, RP-20-98, p. 3.		

(2) Lighting Control.

Lighting shall have automatic controls capable of turning off lighting when sufficient daylight is available or when the lighting is not required during nighttime hours. Lighting not designated for dusk-to-dawn operation shall be controlled by an astronomical time switch or time switch and photo sensor with the following exceptions:

- (iii) Emergency lighting that is automatically off during normal building operation;
- (iv) Lighting that is specifically designated as required by a health or life safety statute, ordinance, or regulation; or
- (v) Decorative gas lighting systems.

(3) Maximum Height.

The height of the light structure shall not exceed twenty-eight (28) feet above grade, except as required by Section 29-4.7 (Neighborhood Protection Standards).

(4) Building Mounted Lighting.

Areas of parking lots, circulation drives, loading areas and drive-thru lanes located near the perimeter of a building may be illuminated by building-mounted lights provided the design of the lights conform to the standards of Section 29-4.5(j) below and as documented in the lighting plan.

29-4.5(h) - Service Station Canopy and Apron Lighting.

The following standards apply to gasoline service stations in addition to the parking lot lighting regulations in subsection 29-4.5(g).

(1) Minimizing Glare.

To minimize glare, no drop, sag or convex lenses shall be used on lighting under the canopy unless the lenses are recessed within the canopy ceiling or shielded by appropriate glare shields. No lighting shall be mounted on building or canopy fasciae or rooftops unless the fixtures are full cutoff. The intent is to keep all the light under the canopy. This lighting shall be provided with low glare luminaires.

(2) Maximum Illuminance.

The maximum average illuminance levels are set forth in Table 4.5-3.

Table 4.5-3: Service Station or Gas Pump Area Illuminance Levels	
Area Description	Maximum Average Illuminance on Described Area (Footcandles)
Approach with dark surroundings	1.5
Driveway with dark surroundings	1.5
Pump island area with dark surroundings	5.0
Building façades with dark surroundings	2.0
Service areas with dark surroundings	2.0
Landscape highlights with dark surroundings	1.0
Approach with light surroundings	2.0
Driveway with light surroundings	2.0
Pump island area with light surroundings	10.0
Building façades with light surroundings	3.0
Service areas with light surroundings	3.0
Landscape highlights with light surroundings	2.0

From "Lighting for Exterior Environments: IESNA Recommended Practice," RP-33-99, p. 43.

29-4.5(i) - Outdoor Display Area Lighting.

Illumination of outdoor display areas for sale of automobiles, recreational vehicles, and manufactured homes and other finished products customarily displayed outdoors shall be permitted in accordance with Table 4.5-4 and with the following:

- (1) Maximum height of light fixtures same as parking lots.
- (2) To minimize glare, no drop, sag or convex lenses shall be used on display-area lighting. Glare shields shall be used to eliminate visibility of the light source from the public roadway.
- (3) The maximum footcandles allowed on adjacent property is one-half (0.5) for residential and two (2.0) for non-residential, and maximum illuminance shall comply with Table 4.5-4.

Table 4.5-4: Illuminance Levels for Outdoor Display Lighting		
Area	Maximum Illuminance on Pavement (Footcandles)	Maximum-to-Minimum Ratio
Adjacent to roadway	10—20	5:1
Other areas	5—10	10:1
Entrances	5—10	5:1
Driveways	2—3	10:1

From "Lighting for Exterior Environment: IESNA Recommended Practice," RP-33-99, p. 43

29-4.5(j) - Building Lighting.

Building lighting shall comply with the following standards.

- (1) Location and Direction.
 - (i) Building mounted lights shall be mounted and installed so that all light is directed downward, unless the lights are decorative lighting.
 - (ii) Fixtures shall be full cutoff or semi-cutoff.
 - (iii) No wall packs or similar lights shall be permitted unless the cutoff angle effectively eliminates visible glare from beyond the property lines.
 - (iv) No light fixtures shall be mounted above the parapet or, for pitched roofs, above the eave except motion-detection security lighting, decorative lighting and accent lighting.
 - (v) Functional lighting shall not exceed four hundred (400) watts of incandescent illuminance or the equivalent. Decorative or accent lighting shall not exceed one hundred (100) watts of incandescent illuminance or the equivalent.
 - (vi) The maximum footcandles allowed on adjacent property is one-half (0.5) for residential and two (2.0) for non-residential.
 - (vii) If swivel mountings are used, lights may be raised a maximum of twenty (20) degrees from horizontal and may not be mounted above the buildings.
 - (viii) The maximum average illuminance levels for floodlighting buildings and monuments are set forth in Table 4.5-5.

Table 4.5-5: Illuminance Levels for Floodlighting Buildings and Monuments	
Area Description	Maximum Average Illuminance (Vertical) (Footcandles)
Bright surroundings and light surfaces	5
Bright surroundings and medium light surfaces	7
Bright surroundings and dark surfaces	10
Dark surroundings and light surfaces	2
Dark surroundings and medium light surfaces	3
Dark surroundings and medium dark surfaces	4
Dark surroundings and dark surfaces	5
From "Lighting for Exterior Environments: IESNA Recommended Practice," RP-33-99, p. 30.	

(2) Decorative Lighting.

Decorative building lighting, in which the purpose is enhancement of building appearance, shall be permitted and may be directed toward the building, provided that all light is cast against the building surface.

- (i) Lighting fixtures shall be carefully located, aimed and shielded so that light is directed only onto the building Façade. Lighting fixtures shall not be directed toward adjacent streets or roads.
- (ii) Lighting fixtures mounted on the building and designed to wash the Façade with light are preferred.

29-4.5(k) - Landscape Lighting.

Landscape lighting shall comply with the following standards:

- (1) Luminaires shall be mounted four (4) feet or lower to the ground.
- (2) The photometric plan shall show the location of all landscape lighting fixtures and the landscaping feature each fixture is to illuminate. The plan shall demonstrate that the installation shall not generate excessive light levels, cause glare, or direct light beyond the landscaping into the night sky.

29-4.5(l) - Athletic Field and Outdoor Arena Lighting .

The following standards apply to the illumination of athletic fields and outdoor arenas:

(1) Minimum and Maximum Lighting.

Athletic fields, where nighttime activity is authorized, shall provide adequate illumination for the scheduled activities. The minimum and maximum light levels shall meet the standards for sports lighting set forth in "Sports and Recreational Area Lighting," RP-6-01, published by the Illuminating Engineering Society of North America. Lighting shall use cutoffs so that light is primarily aimed at and directed to the activity area.

(2) Fixture Height.

Athletic field other than adult baseball fields and arena lighting fixtures shall not exceed seventy (70) feet above finished grade directly below the lighting fixture. Adult baseball field lighting fixtures shall not exceed eighty (80) feet above finished grade directly below the lighting fixture.

(3) Hours of Operation.

Lighting, except for lights reasonably necessary for security purposes, shall be turned off within two (2) hours after the event or closure of the facility, or when required by other regulatory ordinance. Dusk to dawn lights for security purposes shall not emit visible glare from the perspective of adjacent properties, internal access aisles and public streets.

(4) Maximum Footcandles.

The maximum footcandles allowed on adjacent property is one (1.0) footcandle on residential properties and four (4.0) footcandles on non-residential properties.

29-4.5(m) - Private Street Lighting.

Private street lighting is permitted provided the fixtures, wattage and output, fixture height, and spacing are comparable to the public street lighting standards set forth in Chapter 27 (Utilities) Sections 27-146 through 27-151 (Street Lighting) of the City's Municipal Code.

29-4.5(n) - Security Lighting.

Security lighting shall comply with the following standards:

- (1) All security lighting fixtures shall be shielded and aimed so that illumination is directed only to the designated area and not cast on other areas. Lighting shall not be directed above a horizontal plane through the top of the lighting fixture, and the fixture shall include shields that prevent the light source or lens from being visible from adjacent roadways and properties. The use of general floodlighting fixtures is prohibited.
- (2) The maximum footcandles allowed on adjacent property is one-half (0.5) for residential and two (2.0) for non-residential.

29-4.5(o) - Sign Lighting.

Illumination of signs shall conform to Section 29-4.7 (Sign Standards) of this Code. Location of illuminated signs and any lighting fixtures external to the signs shall be included on a lighting plan.

29-4.6 Design Standards and Guidelines.

29-4.6(a) – Intent.

The intent of this section is to:

- (1) Allow full development of properties consistent with the dimensional standards established in Article 2 of Chapter 29 and Section 29-4.1 while establishing baseline requirements for building and site features that will create stable residential neighborhoods, mixed use, commercial, and industrial areas;
- (2) Enhance the public realm;
- (3) Reduce conflicts between existing and new structures;
- (4) Encourage effective development of street frontages and other public elements that enable new projects to add value to existing communities;
- (5) Encourage creative and sustainable design responses to contemporary opportunities; and

- (6) Improve the overall design quality of the City through the use of objective standards that can be administered by the Community Development Department without the need for individualized design review of projects.

29-4.6(b) – Applicability.

- (1) The standards of this section shall apply to all new development in any District except:
 - (i) Development or redevelopment in the M-DT District (Section 29-4.2).
 - (ii) Structures in which the principal use is one of the following use categories or subcategories as shown in Permitted Use Table 29-3.1.
 - (A) One-family Detached residential;
 - (B) One-family Attached residential;
 - (C) Two-family residential;
 - (D) Park or Playground;
 - (E) Utilities;
 - (F) Parking Lot or Structure (primary use);
 - (G) Urban Agriculture;
 - (H) Farmer’s Market; or
 - (I) Industrial (except Artisan Industry).
 - (iii) A change in the principal use of an existing structure that does not alter the exterior of the structure, or only affects the signage on the exterior of the structure.
- (2) In the case of a conflict between the design standards in this section and design standards applicable to a particular project because of its location in an overlay district listed in Section 29-2.3 (Overlay Zoning Districts), or because of a use-specific standard in Section 29-3.3 (Use-Specific Standards), the provisions of the overlay district or use-specific standard shall govern.

29-4.6(c) - Design Standards and Guidelines.

- (1) Entries.

Each principal building shall have one or more operating entry doors facing and visible from an adjacent public street. The location of the entry on the building façade shall be emphasized by the use of different materials, wall articulation around the entry, or foundation plantings around the entry.

- (2) Transparency.

- (i) When the primary use of the ground floor frontage of a structure categorized as Food and Beverage Service, Office, Personal Services, or Retail in Table 29-3.1, a minimum of twenty (20) percent of each Façade area that faces a public street shall be composed of transparent materials.

- (ii) At least one-half of this amount shall be provided so that the lowest edge of the transparent materials is no higher than four (4) feet above the street level.
- (iii) If the Director determines that transparent materials are not practical for security reasons or based on the nature of the permitted ground floor use, an alternative treatment providing equivalent or better visual interest may be approved.

(3) Wall Plane Articulation.

When the primary use of the building is not categorized as Industrial in Table 29-3.1, each Façade greater than one hundred (100) feet in length abutting a public street shall incorporate architectural features such as wall plane projections, recesses, or other building material treatments and textures that visually interrupt the wall plane. No uninterrupted length of any Façade shall exceed one hundred (100) horizontal feet.

(4) Roof Shape.

- (i) When the primary use of the building is not categorized as Industrial in Table 29-3.1, and the building has a sloping roof, at least one projecting gable, hip feature, or other break in the horizontal line of the roof ridgeline shall be incorporated for each one hundred (100) lineal feet of roof.
- (ii) When the primary use of the building is not categorized as Industrial in Table 29-3.1 and the building has a flat roof, the design or height of the parapet shall include at least one change in setback or height of at least three feet along each one hundred (100) lineal feet of façade.

(5) Canopies and Awnings.

All canopies and awnings shall be mounted with a minimum vertical clearance of seven (7) feet between sidewalk grade and the bottom edge of the canopy or awning.

(6) Loading Dock and Delivery Areas.

Loading dock doors and delivery areas shall be located at the rear of buildings to separate customer and employee traffic from loading and service vehicles. The Director may permit alternative locations when:

- (i) Such location would result in docks or delivery areas being adjacent to R-1, R-2, or R-MF zoned lands;
- (ii) Such location would result in excessive or unnecessary impervious surface on the development site;
- (iii) Evidence can be shown that the alternative location will not impact public safety or site circulation; and
- (iv) Alternative loading dock/delivery area are recessed from the building façade such that all loading/unloading activity occurs outside any adjacent public right of way.

29-4.7 Neighborhood Protection Standards.**29-4.7(a) – Intent.**

This section is intended to preserve the residential neighborhood character of established homes within multi-family Districts and adjacent to Mixed Use or Special Districts.

29-4.7(b) – Applicability.

These standards apply:

- (1) To all lots in the R-MF District that contain a principle use other than a single- or two-family dwelling; and
- (2) To all lots located in any District other than the R-1 and R-2 Districts that shares a side or rear lot line with a lot in the R-1 or R-2 District.

29-4.7(c) - Building Height.

Buildings constructed after the effective date of this Code with a height greater than twenty-four (24) feet shall reduce the perceived height of the building when viewed from abutting lots by using at least one (1) of the following techniques.

- (1) “Stepping down” building height of any portion of the building within twenty-five (25) feet of the contiguous side and rear lot lines to a maximum of twenty-four (24) feet.
- (2) Increasing the contiguous side yard and rear yard setbacks a minimum of ten (10) feet beyond that otherwise required in the District where the property is located.

29-4.7(d) - Screening and Buffering.

The standards of Section 29-4.4(e) shall apply.

29-4.7(e) - Parking, Loading, and Circulation.

- (1) No parking area, drive-through lane, or vehicle circulation driveway shall be located between a principal structure on a lot containing a use other than a single- or two-family use and any side property line abutting a lot containing a single- or two-family dwelling.
- (2) If the context of a site makes subsection (1) above impractical, the Director may approve a parking lot design that locates a parking area, drive-through lane, vehicle circulation driveway, or a combination of these three site planning elements, in the area described in subsection (1) above, provided all of those three site planning elements are located at least six (6) feet from an adjacent lot containing a single- or two-family dwelling.

29-4.7(f) - Lighting Height.

The maximum height of any lighting pole within fifty (50) feet of the side or rear lot lines shall be 20 feet.

29-4.7 Sign Standards.**29-4.8(a) – Purpose.**

The purposes of these sign regulations are:

- (1) To allow the effective use of signs as a means of communication in the City;
- (2) To maintain and enhance the City's ability to attract sources of economic development and growth;
- (3) To improve pedestrian and traffic safety;
- (4) To minimize possible adverse effects of signs on nearby property;
- (5) To bring all signs into compliance with adopted regulations;
- (6) To enable the fair and consistent enforcement of these sign regulations;
- (7) To maintain and enhance the appearance of the community; and
- (8) To comply with all applicable federal and state laws regarding the First Amendment and free speech.

29-4.8(b) – Applicability.

- (1) The standards of this Section 29-4.8 apply to the erection of any sign of any type within the City, unless specifically exempted or excluded by a provision of this Code. In addition to the provisions of this Section 29-4.8, all properties must comply with any sign regulations contained in any Use-specific Standard in Section 29-3.3 applicable to the property. In the event of a conflict between the standards of this Section 29-4.8 and the sign standards in any approved PD District, the standards in the approved PD District shall apply.
- (2) Any sign authorized to be displayed by this Code may contain any non-commercial message.
- (3) Notwithstanding any other provision of the City Code, the standards of this Section relating to non-commercial signs shall in all instances be construed to operate in a content neutral manner. Any description of the type of message or content of any non-commercial sign authorized by this Section shall not be construed to be a prescription of or limitation on the type of non-commercial message or content that can be displayed, rather, any such description shall be construed as merely illustrative of the type of non-commercial sign that potentially may be deployed..

29-4.8(c) - Prohibited Signs.

- (1) No sign shall be erected in such a manner that it will or reasonably may be expected to interfere with, obstruct, confuse, distract or mislead traffic, or be considered obscene or a nuisance to the general public.

- (2) No person, except a public officer or an employee in the performance of a public duty, shall fasten any sign or notice of any kind on any curbstone, lamppost, street or sidewalk surface, pole, bridge or tree upon a public street, except for any banner attached to a City street light standard for which an attachment permit has been issued. This prohibition includes, but is not limited to, advertisements and announcements of buildings or land for sale or rent, garage sales, private picnics and election campaign posters. This prohibition is not to be construed as prohibiting signs or notices indicating danger or aids to service or safety, or subdivision identification signs, to be erected with written permission from the Director.
- (3) No signs painted on buildings, walls or fences shall be allowed.
- (4) No wind signs shall be allowed.
- (5) No freestanding, on-premises commercial sign, including the supporting structures, shall be allowed to remain on any property more than six (6) months after the business or uses advertised on the sign have been discontinued.
- (6) No sign shall be erected or maintained in a location or in such a manner that any portion of the sign will be within ten (10) feet, measured either horizontally, vertically or at any intermediate angle, of any electric power line wire carrying a voltage in excess of two hundred forty (240) volts, nor shall any sign be within ten (10) feet of a vertical line extended upward from such an electric power line wire.
- (7) No portable signs shall be allowed, except for sandwich board signs in the M-DT District.
- (8) No animated signs shall be allowed.
- (9) No off-premise signs or billboards shall be allowed, except as provided in Section 29-4.8(d)(5).
- (10) No commercial signs shall be allowed except as provided for in this Section 29-4.8.
- (11) No commercial flags shall be allowed except that a business may display one flag no larger than forty (40) square feet which bears the symbol or trademark or name of the business. No further advertising shall be permitted on such flags.
- (12) No digital signs shall be allowed.

29-4.8(d) - Regulations Based on Use and Area.

- (1) Residential Use Signs.
 - (i) Table 4.8-1 sets forth signs standards for identification and sale, rental, or lease signs permitted for certain residential uses and land areas.

Table 4.8-1: Residential Use Signs – Identification (ID) & Sale/Rent						
	Single- or Two- Family		Multiple-Family		Manufactured Home	Land
Type	ID	Sale/Rent	ID	Sale/Rent	ID	Sale/Lease
Maximum Number	1/each street frontage				See Section 29-4.10(e)	1/lot
Maximum Area	7.5 sq. ft.	7.5 sq. ft.	15 sq. ft.	7.5 sq. ft.		Lots greater than 1 acre: 12 sq. ft./acre; 32 sq. ft. (max) Lots less than 1 acre: 12 sq. ft.
Location	On premises					
Other						

(ii) Identification of Subdivision or Neighborhood Area.

Identification signs for subdivisions and residential areas are regulated by Section 29-4.8(f)(1). This type of sign may be situated on private property adjacent to the entrance or, by special permission of the Council, may be located on median strips that divide public streets leading into the named subdivision area. If the sign is permitted to be located in the public right-of-way, the design and location of the sign shall first be approved by the Director and the following criteria shall be met:

- (A) Minimum setback at an intersection shall be twenty-five (25) feet.
- (B) Minimum width of an island on which a sign is to be located shall be eight (8) feet.
- (C) Location on the island or median strip shall be along the centerline of the median parallel to the entrance street.
- (D) Signs shall be designed and located so as not to interfere with the visibility of traffic at any location.

(iii) Table 4.8-2 sets forth standards for various general sign types allowed on all residential lots.

Table 4.8-2: Residential Use Signs - Other				
	Open House/Model Home	Solicitation	Garage Sale	Real Estate Sales Office (Temporary)
Type	Advertise open house	Prohibit solicitors, peddlers, hawkers, itinerant merchants, or transient vendors from entering private property	Advertise garage sale conducted on premises	Identify a temporary real estate sales office
Maximum Number	3/property	1/property	1/each street abutting the premises	1/property
Maximum Area	4 sq. ft./sign	1 sq. ft.	4 sq. ft./sign	6 sq. ft.
Maximum Height				4 ft.
Location	On or Off premises	On premises	On premises	On premises
Other	Signs shall be permitted 48 hours prior to the time the house is open for viewing and removed one hour after closure of viewing time.		Signs are only permitted during the time of the sale	

(2) Business Use Signs Outside the M-DT District and within Urban General West Building Form Standard.

The following standards apply to all signs that are related to a use that is not a residential use or an industrial use, as shown in Table 29-3.1 (Permitted Use Table) and that is not located in the M-DT District (Section 29-4.2).

- (i) Table 4.8-3 sets forth standards for wall, projecting, and roof signs for all business uses outside the M-DT District including businesses within the Urban General West Building Form Standard, with the exception of shopping centers, office buildings, theaters, automobile service stations, hotels and motels.
- (ii) Table 4.8-4 sets forth standards for sale or lease, identification, and directional signs for all business uses outside of the M-DT District including businesses within the Urban General West Building Form Standard.

Table 4.8-3: Business Use Signs Outside M-DT including Urban General West Building Form Standard by Number & Type				
	Wall	Projecting	Roof	Freestanding
Sign Combinations	Each property may have 2 of the 4 signs in this table, but a business may not to have both a freestanding and a roof sign			
Number	Any combination of wall, canopy, or awning signs, not to exceed the maximum surface area	1	1	1 for each adjacent street R-O-W, per the regulations in Section 29-4.8(e)
Maximum Area	<ul style="list-style-type: none"> ▪ See Section 29-4.8(f)(2) ▪ 1 rear entrance sign; 10 sq. ft. max size 		2 sq. ft./linear ft. of building frontage	
Location	On premises	<ul style="list-style-type: none"> • On premises • Not to exceed 8 ft. in projection from the building wall on each wall facing a street • If a 1-story building, the sign may extend 10 ft. above the roof line or parapet of the building 	Roof of a 1- or 2-story building	
Other		Sign shall not extend above the roof line or parapet of the building, except for a one-story building	Sign shall not extend beyond the highest point of the roof on which it is located	

Table 4.8-4: Business Use Signs – Sale/Lease, etc.

	Sale or Lease		Development Identification	Directional
	Building	Land		
Type	Advertises office or commercial space for sale, rent, or lease	Advertises land for sale or rent	Identifies a commercial development, except for shopping centers (see Table 4.10-5)	
Maximum Number	1	1	1	1
Maximum Area	12 sq. ft.	<ul style="list-style-type: none"> ▪ Greater than one acre: 12 sq. ft./acre; 32 sq. ft. (max) ▪ Less than one acre: 12 sq. ft./acre (max) 	32 sq. ft.	32 sq. ft.
Maximum Height			6 ft.	3 ft. (measured from the grade immediately below the sign)
Location	On premises	On premises		On premises, at each automotive entrance and exit of any business, in any development, except ATMs regulated under Section 29-4.8(12)

(iii) As an alternative to the signs permitted in subsections (i) through (ii) above, Table 4.8-5 sets forth standards for signs permitted if the property is a shopping center:

Table 4.8- 5: Shopping Center Signs

	Shopping Center	Each Separate Business		Businesses with a Rear or Side Entrance
		Wall, Canopy, Awning	Roof	
Maximum Number	1 freestanding master sign/adjacent street ROW			1 wall or awning sign/entrance
Maximum Surface Area	<ul style="list-style-type: none"> ▪ 64 sq. ft./ acre ▪ 288 sq. ft. or ½ sq. ft. in area/ linear ft. of adjacent street ROW the sign is oriented toward, whichever is greater 	<ul style="list-style-type: none"> ▪ Wall facing a street: See Section 29-4.8(e)(2) ▪ Wall facing main shopping center parking area: 64 sq. ft. 	All signs located above any one wall: 4 sq. ft./ linear ft. of wall length occupied by the business	10 sq. ft./entrance
Maximum Height	30 ft.			
Location	Adjacent street ROW	On premises	On premises and located above a wall	
Other	If adjacent street is an arterial street designated for collector street provisions then the freestanding sign must comply with Section 29-4.8(e)		A roof sign shall not extend beyond the highest point of the roof on which it is located	

(3) Signs in M-DT District excluding Urban General West Building Form Standard.

The M-DT District (Section 29-4.2) is intended to be attractive, historic and pedestrian friendly. Accordingly, signs should be smaller in scale and fewer in number. This will enhance the attractiveness of the area, reduce visual clutter, increase property values and encourage tourism and other business.

(i) Applicability.

This section regulates signs within the M-DT District excluding the Urban General West Building Form Standard and with the exception of theaters, which are subject to Section 29-4.8(13).

(ii) General Standards.

(A) Table 4.8-6 sets forth standards for business signs permitted at different building levels within the M-DT excluding buildings within the Urban General West Building Form Standard.

Table 4.8-6: M-DT Business Signs by Building Level, excluding the Urban General West Building Form Standard[1]				
	Awning	Projecting	Wall	Window
Aggregate Size Limitation	15% of the wall space of one building elevation. All signs identified in this Table and Table 4.10 - 7, except for Building Directories and Identification Signs, contribute to this aggregate amount.			
Lower Level				
Maximum Number	1/elevation			
Maximum Area	18 sq. ft.	8 sq. ft.	24 sq. ft.	18 sq. ft.
Placement		<ul style="list-style-type: none"> ▪ Shall not project more than 3 ft. from face of wall ▪ Bottom of sign must be at least 8 ft. from ground ▪ Top of sign must be no more than 12 ft. from ground 	<ul style="list-style-type: none"> ▪ No higher than the bottom of a second level window 	
Street Level [2]				
Maximum Number	2/elevation			
Maximum Area	32 sq. ft.	8 sq. ft.	32 sq. ft.	32 sq. ft.
Placement		See lower level standards above	<ul style="list-style-type: none"> ▪ Below the bottom of the second level window on multi-story buildings 	
Second Level				
Maximum Number	1/elevation			
Maximum Area	18 sq. ft.	8 sq. ft.	<ul style="list-style-type: none"> ▪ Street Level: 24 sq. ft. ▪ Second Level: 18 sq. ft. 	18 sq. ft.
Placement			<ul style="list-style-type: none"> ▪ Street Level: No higher than the bottom of a second level window ▪ Second Level: No higher than the bottom of a third story window 	

Table 4.8-6: M-DT Business Signs by Building Level, excluding the Urban General West Building Form Standard[1]				
	Awning	Projecting	Wall	Window
Upper Level (Third level and above)				
Maximum Number	1/elevation			
Maximum Area	18 sq. ft.	Not allowed	Not allowed	18 sq. ft.
Other			<ul style="list-style-type: none"> If now higher level windows exist, placement may be 40 inches above finished floor level (max.) 	Signs spread across multiple windows will be counted as 1 sign
<p>[1] Single-use Building: A business that occupies an entire building with a frontage equal to or greater than 48 ft. may choose to install only 1 sign per elevation. In that case, the maximum size of the single sign is the lesser of 64 %t of the wall space of 1 elevation, provided all other criteria are met. Wall sign placement is not restricted to below the second story window sill.</p> <p>[2] Large Businesses: Street level tenants with 48 feet or more of frontage and located in multiple-tenant buildings may choose to install only 1 sign per elevation as an alternative to any 2 sign types. In that case, the maximum size of the single sign is the lesser of 48 sq. ft. or 15% of the wall space of 1 elevation, provided all other criteria are met. Wall signs must be placed no higher than the bottom of the second story window sill.</p>				

(B) Table 4.8-7 sets forth standards for other business signs permitted in the M-DT District.

Table 4.8-7: Other M-DT excluding Urban General West Building Form Standard - Business Signs					
	Building Directories	Building Identification	Mobile	Directional	Signs Adjacent to Providence Road
Aggregate Size Limitation			15 % of the wall space of one building elevation. All signs identified in this Table, except Building Directories and Identification Signs, and Table 4.8-6 contribute to this aggregate amount.		
Maximum Number	1/Building Entrance	1/Building	1/street level entrance	1/automotive entrance and exit	Signs on any building elevations adjacent to Providence Road, except for City-owned property or vacant property greater than 150 ft. in depth between the building elevation and the road ROW are subject to the sign regulations outside of the M-DT District in Section 29-4.8.
Maximum Area	6 sq. ft.	18 sq. ft.	8 sq. ft.	8 sq. ft.	
Maximum Height				3 ft. (measured from grade immediately below sign)	
Location			<ul style="list-style-type: none"> On the sidewalk directly in front of the business; Provided that a straight, unobstructed pathway at least 60 inches wide is maintained on the sidewalk 		
Other			Shall not be attached to any property not owned by the business owner to whom the sign is permitted.		

(4) Industrial Use Signs.

(i) Freestanding Signs.

One freestanding sign may be allowed per adjacent street right-of-way and further regulated by Section 29-4.8(f)(1).

(ii) Wall Signs.

In addition to the freestanding sign permitted above, each business shall be allowed on-premises wall, canopy and awning signs not to exceed the maximum surface area allowed under Section 29-4.8(f)(2).

(i) Sale or Lease of Land.

For lots of one acre or larger, one (1) on-premises sign not exceeding twelve (12) square feet in sign surface area per acre, with a maximum sign surface area of thirty-two (32) square feet, is allowed to advertise land for sale or rent. For lots of less than one (1) acre in size, one sign of not exceeding twelve (12) square feet in signs area is allowed.

(iii) Sale or Lease of Building.

One on-premises sign, not exceeding thirty-six (36) square feet in sign surface area, shall be allowed to advertise the sale, lease or rent of industrial space.

(iv) Industrial Parks.

In industrial parks, one industrial park master sign, shall be allowed for each adjacent street right-of-way, in accordance with Section 29-4.8(f)(1).

29-4.8(e) - Regulations Based on Type of Sign.

(1) Banners.

(i) Downtown Community Improvement District.

The Downtown Community Improvement District may attach banners to City street light standards located on public rights-of-way, or within public utility easements, adjacent to public rights-of-way, within an area defined in the petition approved by Ordinance No. 20866. Attachment of the banners shall be done under the following conditions:

(A) The message conveyed relates to cultural, civic or other City wide activities.

(B) The Downtown Community Improvement District, after executing an attachment agreement with the City, shall have the exclusive right to install banners on City street light standards in the above-described area. The attachment agreement shall set out requirements for the design of attachment brackets and installation, removal, maintenance, and responsibility for such attachment brackets and banners. Said requirements shall be set out in banner regulations promulgated by the City manager and reviewed annually and approved by the Council.

(C) Banners shall conform to design specifications established by the Downtown Community Improvement District.

(ii) College, University, or Hospital.

A college, university or hospital may attach banners to City street light standards located on public rights-of-way, or within public utility easements, adjacent to the campus of the college, university or hospital. Attachment of the banners shall be done under the following conditions:

(A) The banners shall be limited to identifying the name of the college, university or hospital or conveying a message related to cultural, civic or City-wide activities.

(B) The college, university or hospital, after executing an attachment agreement with the City, shall have the exclusive right to install banners on the City street light standards described in the agreement. The attachment agreement shall set out requirements for the design of attachment brackets and installation, removal, maintenance, and responsibility for such attachment brackets and banners.

(iii) Library.

Notwithstanding any other provisions of this Section 29-4.8, a public library may display banners subject to the following conditions:

(A) Attachment to City street light standards.

Upon entering into an attachment agreement with the City, a public library may attach banners to City street light standards located on public rights-of-way, or within public utility easements, adjacent to the library premises, including library parking lots. The library, after executing the attachment agreement with the City, shall have the exclusive right to install banners on the City street light standards described in the agreement. The attachment agreement shall set out requirements for the design of attachment brackets and installation, removal, maintenance and responsibility for such attachment brackets and banners.

(B) Attachment to library light standards and sign poles.

A public library may attach banners to library light standards and to library sign poles.

(C) Parking lot sign poles.

Each library parking lot shall be allowed up to four (4) banner sign poles for each adjacent street right-of-way. The banners on the poles shall be the same height as the banners on the library light standards in the lot. The poles shall be located at least four (4) feet from the street right-of-way.

(D) Banner content.

The banners shall be limited to identifying the name of the library or library facility or conveying a message related to a cultural, civic or City-wide activity. No banner can carry a political or nonsecular message.

(E) Banner number and size.

There is no limit on the number of banners, however, banners shall not exceed sixteen (16) square feet in sign surface area per side or a total of thirty-two (32) square feet per banner.

(F) Banners other than for library identification.

If a banner is for a purpose other than identifying the library or library facility, the banner shall not remain in place for more than thirty (30) days.

(2) Billboards.

(i) Locations.

Billboards shall be allowed in areas zoned M-N, M-C, M-DT, or a PD District permitting commercial uses, M-BP, or IG, provided that the location is within sixty (60) feet of the nearest edge of the right-of-way of:

(A) Any interstate (I-70); or

(B) Any freeway (U.S. 63); or

(C) Any other highways where the City is mandated by law to allow billboards.

(ii) Regulations.

All billboards shall comply with the following regulations:

(A) Billboards shall be oriented toward traffic on the interstate, freeway or highway.

(B) No billboard along any interstate shall be erected closer than two thousand (2,000) feet from another billboard. No billboard along any freeway shall be erected closer than four thousand (4,000) feet from another billboard. No billboard along any highway shall be erected closer than one thousand (1,000) feet from another billboard.

(C) No billboard shall be erected closer than five hundred (500) feet from any area zoned R-1, R-2, R-MF, R-MH, A, a PD District that allows residential uses, or any equivalent county zoning.

(D) No billboard shall be erected closer than five hundred (500) feet from any residential structure.

(E) No billboard shall be erected closer than five hundred (500) feet from any religious institution, elementary/secondary school, or public park, playground or golf course.

(F) No billboard shall be erected closer than five hundred (500) feet from any historical site or historical district so designated by the federal, state or City government.

(G) No billboard shall be erected closer than one hundred (100) feet from any on-premises freestanding sign.

(H) No billboard shall be erected within five hundred (500) feet of an interchange or intersection at grade. The five hundred (500) feet shall be measured from the

beginning or ending of the pavement widening at the exit from or entrance to the main traveled way.

- (I) The maximum height of a billboard along any interstate is forty-five (45) feet. The maximum height of a billboard along any freeway is thirty (30) feet. The maximum height of a billboard along any highway is twelve (12) feet.
- (J) The maximum surface area of a billboard along any interstate is two hundred eighty-eight (288) square feet. The maximum surface of a billboard along any freeway is one hundred twenty-eight (128) square feet. The maximum surface area of a billboard along any highway is seventy-two (72) square feet.
- (K) Billboards shall have only one sign surface area except that billboards may have two (2) sign surface areas if the surface areas are oriented in opposite directions. No V-shaped billboards are allowed.
- (L) External lighting of billboards, such as floodlights, thin line and gooseneck reflectors are permitted, provided the light source is directed upon the face of the sign and is effectively shielded so as to prevent beams or rays of light from being directed toward any residential structure or into any portion of the main traveled way of the interstate, freeway, or highway, and the lights are not of such intensity so as to interfere with the residential use of property or to cause glare, impair the vision of the driver of a motor vehicle, or otherwise interfere with a driver's operation of a motor vehicle.
- (M) No billboard shall have wind-actuated elements or any material that glistens or sparkles.
- (N) No billboard shall be erected closer than five hundred (500) feet from a City greenspace access easement, greenspace conservation easement or greenspace trail easement.
- (O) No billboard shall have any revolving, moving, flashing, blinking or animated characteristics.
- (P) No billboard shall have any electronic, digital, tri-vision or other changeable copy display.

(3) Civic Signs.

One on-premises freestanding sign shall be allowed for any religious institution or governmental entity per street block in accordance with Section 29-4.8(f)(1). One on-premises illuminated wall sign for each street frontage shall be allowed in accordance with Section 29-4.8(f)(2).

(4) Construction Signs.

One (1) on-premises unilluminated construction sign, a wall or freestanding sign, which may indicate the names of architects, engineers, builders, contractors, owners and financial institutions shall be allowed at the site of construction, provided such signs shall be erected only after the issuance of a City building permit and removed upon issuance of a certificate of occupancy by the City. The maximum height shall be eight (8) feet and the maximum size shall be sixty-four (64) square feet.

(5) Hotel Signs.

Motels and hotels shall be allowed the following signs:

(i) Wall Signs.

Motels and hotels shall be allowed on-premises wall, canopy and awning signs on each wall facing a street, with the sign surface area not to exceed the maximum surface area allowed under Section 29-4.8(f)(2).

(ii) Projecting Sign.

Except in the central business district, one on-premises projecting sign not to exceed eight (8) feet in projection from the building wall shall be allowed on each wall facing a street. In the case of a one-story building, such signs may extend ten (10) feet above the roof line or parapet of the building. In all other cases such signs shall not extend above the roof line or parapet of the building.

(iii) Freestanding Signs.

One on-premise freestanding sign in accordance with Section 29-4.8(f) (except that only one shall be allowed).

(iv) Supplemental Signs.

Supplemental signs, not to exceed three (3) for each street frontage, may be used to advertise additional facilities and services (restaurant, bar, night club, etc.) available at the motel or hotel. Such supplemental signs shall be wall signs and shall have a maximum sign surface area of one hundred (100) square feet per street frontage.

(v) Marquee Signs.

Hotels with an entrance marquee shall be permitted one (1) marquee sign with a maximum sign surface area not to exceed two (2) square feet per linear foot of frontage for the marquee.

(6) Light Vehicle Service and Repair Signs.

Light vehicle service and repair establishments shall be allowed a total of three (3) of the following four (4) signs:

- (i) One freestanding sign, indicating the name, emblem or symbol of the company, in accordance with Section 29-4.8(f)(1).
- (ii) One on-premises freestanding sign, indicating services available, in accordance with Section 29-4.8(f)(1).
- (iii) On-premises wall, canopy and awning signs not exceeding the maximum surface area allowed under Section 29-4.8(f)(2).
- (iv) One on-premises roof sign not exceeding two (2) square feet in sign surface area per linear foot of building frontage. No roof sign shall extend beyond the highest point of the roof upon which it is located.

(7) Noncommercial Signs.

Except as otherwise allowed or restricted in this Section 29-4.8, noncommercial signs are subject to the following restrictions:

- (i) They shall be ground or wall signs, except when placed in a location where other types of signs are allowed.
- (ii) They shall not exceed sixteen (16) square feet in sign surface area per premises; provided that any noncommercial sign may have a sign surface area as large as that of any allowable sign in the same location.
- (iii) They shall not exceed a maximum height of ten (10) feet; provided that any noncommercial sign may be as high as any allowable sign in the same location.
- (iv) The area and height limitations of this Section 29-4.8(e)(10) shall not apply to any noncommercial message placed on a structure that has existed as a nonconforming billboard.
- (v) Any structure that may be lawfully used for an on-premises commercial sign may be used for a noncommercial sign.
- (vi) The restrictions of this subsection shall not apply to banners on the campus of any college, university or hospital.

(8) Parking Lot Signs.

On-premises wall or freestanding signs designating the conditions of use or identity of an automobile parking area and not less than eighteen (18) inches by twenty-four (24) inches in dimension, nor greater than thirty-two (32) square feet in sign surface area, shall be allowed. Freestanding signs shall not be more than eight (8) feet in height, and shall be set back a minimum of ten (10) feet from the property line.

(9) Automatic Teller Machine (ATM) Signs.

(i) Directional Signs.

One (1) on-premises sign, not exceeding eight (8) square feet in sign surface area, and not exceeding three (3) feet in height as measured from the grade immediately below the sign, shall be allowed at each automotive entrance and exit to the ATM.

(ii) Stand-alone Signs.

A stand-alone automatic teller machine shall be allowed a total of seventy-five (75) square feet of wall or canopy sign surface area. The sign surface area shall be determined as the area of the basic geometric shape that encloses the message. Sign area for an automated teller machine located within the footprint of an occupied building shall be considered as part of the permitted wall sign surface area for the occupied building.

(10) Theater Signs.

Notwithstanding any other provisions of this Section 29-4.8, theaters and drive-in theaters shall be allowed any two (2) of the following five (5) types of signs:

- (i) One marquee sign not to exceed two (2) square feet for every linear foot of building frontage.
- (ii) One wall sign not to exceed the maximum surface area allowed under Section 29-4.8(f)(2).
- (iii) One freestanding sign with a maximum of two hundred eighty-eight (288) square feet in area and thirty (30) feet in height. However, no sign shall be greater in area than thirty-two (32) square feet for each screen in the theater, plus thirty-two (32) square feet.
- (iv) Each establishment of one or two (2) stories may be allowed one on-premises roof sign for each wall facing a street. The maximum sign surface area shall be determined at the rate of two (2) square feet per linear foot of building frontage. No roof signs shall exceed the highest point of the roofs upon which they are located.
- (v) One awning sign not to exceed the maximum surface area allowed under Section 29-4.8(f)(2).

(11) Temporary Signs.

Temporary signs may be allowed subject to the following conditions:

- (i) A permit in accordance with Section 29-6.4(f) shall be required.
- (ii) Such signs shall not exceed thirty-two (32) square feet in size or four (4) feet in height.
- (iii) The sign setback requirements of this chapter shall apply.
- (iv) No person shall be allowed to display a temporary sign or signs on a parcel of land for more than fourteen (14) days in a calendar year.

(12) Time and Temperature Signs.

Time and temperature signs with a maximum sign surface area of thirty (30) square feet may be placed in any commercial or industrially zoned district, subject to all other restrictions on signs in the commercial or industrially zoned district in which they are placed.

29-4.8(f) - Area, Height and Placement Standards.

(1) Freestanding Signs.

- (i) Freestanding signs shall be regulated by the standards in Table 4.8-8 as modified by the provisions of subsections (ii) or (iii), below, and by other regulation of this subsection.

Table 4.8-8: Free Standing Sign Regulations					
Street Class	R-1, R-2, and A-1	R-MF and R-MH	M-OF	M-N, M-C, M-BP	I-G
Local residential	For buildings originally designed and constructed for residential occupancy; only 1 sign per site. 16 sq. ft. max area, 4 ft. max ht. Must be a monument sign. All other buildings: 32 sq. ft. max. area, 6 ft. max. ht. Must be a monument sign.	For buildings originally designed and constructed for residential occupancy; only 1 sign per site. 16 sq. ft. max area, 4 ft. max ht. Must be a monument sign. All other buildings: 32 sq. ft. max. area, 6 ft. max. ht. Must be a monument sign.	32 sq. ft. max. area, 6 ft. max. ht.	32 sq. ft. max. area, 6 ft. max. ht.	32 sq. ft. max. area, 6 ft. max. ht.
Collector or local nonresidential	For buildings originally designed and constructed for residential occupancy; only one sign per site. 16 sq. ft. max area, 4 ft. max ht. Must be a monument sign. All other buildings: 32 sq. ft. max. area, 6 ft. max. ht. Must be a monument or pylon sign	For buildings originally designed and constructed for residential occupancy; only one sign per site. 16 sq. ft. max area, 4 ft. max ht. Must be a monument sign. All other buildings: 32 sq. ft. max. area, 6 ft. max. ht. Must be a monument or pylon sign	48 sq. ft. max. area, 10 ft. max. ft.	64 sq. ft. max. area, 12 ft. max. ht.	64 sq. ft. max. area, 12 ft. max. ht.
Arterial	32 sq. ft. max. area, 6 ft. max. ht. (Must be a monument or pylon sign)	32 sq. ft. max. area, 6 ft. max. ht. (Must be a monument or pylon sign)	64 sq. ft. max. area, 12 ft. max. ht.	64 sq. ft. max. area, 12 ft. max. ht., for each 1.25 ft. setback, add 3.55 sq. ft./128 max. and 1 ft. ht. to 30 ft. max.	64 sq. ft. max. area, 12 ft. max. ht., for each 1.25 ft. setback, add 3.55 sq. ft./ 128 max. and 1 ft. ht. to 30 ft. max.
Expressway	32 sq. ft. max. area, 6 ft. max. ht.	32 sq. ft. max. area, 6 ft. max. ht.	64 sq. ft. max. area, 12 ft. max. ht.	64 sq. ft. max. area, 12 ft. max. ht., for each 1.25 ft. setback, add 3.55 sq. ft./128 max. and 1 ft. ht. to 30 ft. max.	64 sq. ft. max. area, 12 ft. max. ht., for each 1.25 ft. setback, add 3.55 sq. ft./128 max. and 1 ft. ht. to 30 ft. max.
Interstate freeway	32 sq. ft. max. area, 6 ft. max. ft.	128 sq. ft. max. area, 12 ft. max. ht.	128 sq. ft. max area, 30 ft. max. ht.	128 sq. ft. max. area, 30 ft. max. ht., for each 2.00 ft. setback, add 10.65 sq. ft./288 max. and 1 ft. ht. to 45 ft. max.	128 sq. ft. max. area, 30 ft. max. ht., for each 2.00 ft. setback, add 10.65 sq. ft./288 max. and 1 ft. ht. to 45 ft. max.

- (ii) Notwithstanding the existing street classifications, the area, height and placement of freestanding signs on property adjacent to the following arterial streets, because of their proximity to existing or planned residential neighborhoods and environmentally sensitive areas, shall be regulated by the collector street provisions of the Table 4.8-8.
 - (A) Stadium Boulevard (State Rt. E) north of Interstate 70
 - (B) Creasy Springs Road
 - (C) Paris Road south of Business Loop 70
 - (D) Waco Road
 - (E) Mexico Gravel Road/Brown Station Road
 - (F) Ballenger Lane
 - (G) Clark Lane, east of Olympic Boulevard
 - (H) Broadway, east of Tenth Street and west of Sixth Street
 - (I) New Haven Road
 - (J) Old 63
 - (K) College Avenue
 - (L) Rangeline Street from Rogers Street to Business Loop 70
 - (M) Providence Road between Stewart Road and Stadium Boulevard; and, north of Bear Creek
 - (N) Nifong Boulevard, west of Monterey Drive and east of Buttonwood Drive
 - (O) Forum Boulevard
 - (P) West Boulevard
 - (Q) Scott Boulevard
 - (R) Chapel Hill Road
 - (S) Sinclair Street
 - (T) Old Plank Road.
 - (U) Vandiver Driver, east of Parker Street
- (iii) The area, height and placement of freestanding signs on property adjacent to the following collector and local, non-residential streets, because they serve established business areas or are near an interstate or expressway, shall be regulated by the arterial street provisions of the Table 4.8-8:
 - (A) I-70 Drive Northwest from Stadium Boulevard to Garden Drive
 - (B) I-70 Drive Southwest
 - (C) I-70 Drive Southeast
 - (D) West Worley Street from eight hundred (800) ft. east of Bernadette Drive to one thousand five hundred (1,500) ft. west of Stadium Boulevard

- (E) West Ash Street from eight hundred (800) ft. east of Bernadette Drive to one thousand five hundred (1,500) ft. west of Stadium Boulevard
 - (F) Bernadette Drive from Stadium Boulevard to West Worley Street
 - (G) Fairview Road between Bernadette Drive and Bernadette Place
 - (H) Bernadette Place
 - (I) Knipp Street
 - (J) Hutchens Drive
 - (K) Beverly Drive
 - (L) Green Meadows Road from Providence Outer Roadway to one hundred fifty (150) feet west of Green Meadows Way
 - (M) Parkade Boulevard from Business Loop 70 to Interstate 70
 - (N) Garth Avenue from Business Loop 70 to Interstate 70
 - (O) Indiana Avenue
 - (P) Grand Avenue from Business Loop 70 to Dakota Avenue
 - (Q) Colorado Avenue
 - (R) Dakota Avenue
 - (S) Illinois Avenue
 - (T) Nebraska Avenue
 - (U) 7th Street from Business Loop 70 to Interstate 70
 - (V) Commerce Court
 - (W) Hathman Place
 - (X) Bowling Street, south of Business Loop 70
 - (Y) Belmont Street
 - (Z) Peach Tree Drive
- (iv) The interstate and freeway category in Table 4.8-8 shall apply only to property within one hundred (100) feet of the right-of-way of Interstate 70 and U.S. 63 and property, either in whole or in part, within one thousand (1,000) feet of the mid-point of the intersections with Interstate 70 and U.S. 63.
 - (v) Street classifications are defined by the Major Thoroughfare Plan of the City of Columbia and the Subdivision Regulations of the City of Columbia.
 - (vi) Freestanding signs located on interior lots shall be set back from each side lot line a distance equal to twenty-five (25) percent of the lot width. On corner lots, the side setback shall be equal to twenty-five (25) percent of the lot width and applied only to the side lot line not adjacent to a street right-of-way.
 - (vii) Freestanding signs shall, at a minimum, be set back ten (10) feet from the right-of-way line, except that freestanding signs located on through lots shall be set back from the right-of-way lines no more than one-half ($\frac{1}{2}$) the lot depth. Freestanding signs located

on corner lots abutting three (3) or more street rights-of-way shall be set back from the front and rear lot lines no more than one-half (½) the lot depth.

- (viii) Where increased sign area and height are allowed by reason of increased setback, the setback shall be measured from the point of minimum setback.
- (ix) In any PD District that allows non-residential uses, freestanding sign area, height, placement and number shall be subject to review and approval of development plans or final development plans. Specific regulations shall be recommended to and approved by the Council as part of a development plan or final development plan, or in the case of minor revisions, by the Commission or the Director Changes to specific sign regulations within a development plan shall only be approved through compliance with zoning ordinance procedures for review and approval of development plans and final development plans and changes to them.
- (x) Within M-DT District (Section 29-4.2), signage shall be regulated by the provisions of Section 29-4.8(d)(3).
- (xi) Freestanding sign regulations for R-1, R-2, R-MF and R-MH Districts found in Table 4.8-8 shall only be applicable to signs for identification of manufactured home parks and subdivisions or neighborhood areas regulated under Section 29-4.1029-4.7. Any non-residential uses allowed in the A, R-1, R-2, and R-MF Districts shall be allowed freestanding signage in accordance with Table 4.8-8.

(2) On-premises Wall, Canopy and Awning Signs.

- (i) On-premises wall, canopy and awning signs shall be regulated by the following Table 4.8-9 of sign regulations in accordance with the more detailed regulations of this section:

Street Class	R-1, R-2, and A-1	R-MF and R-MH	M-OF	M-N, M-C, M-DT, M-BP	I-G
Local Residential	32 sq. ft. max area	32 sq. ft. max area	32 sq. ft. max area	32 sq. ft. max area	32 sq. ft. max area
Collector or Local Non-Residential	32 sq. ft. max area	32 sq. ft. max area	48 sq. ft. max area	64 sq. ft. max area; except that if the business does not have a freestanding sign, for each 1.25 feet of setback, add 3.55 sq. ft. to a 128 sq. ft. max	64 sq. ft. max area; for each 1.25 setback add 3.55 sq. ft. to a 128 sq. ft. max area
Arterial	32 sq. ft. max area	32 sq. ft. max area	64 sq. ft. max area	64 sq. ft. max area; for each 1.25 ft. setback, add 3.55 sq. ft. to a 192 sq. ft. max area	64 sq. ft. max area; for each 1.25 ft. setback, add 3.55 sq. ft. to a 192 sq. ft. max area
Expressway	32 sq. ft. max area	32 sq. ft. max area	64 sq. ft. max area	64 sq. ft. max area; for each 1.25 ft. setback, add 3.55 sq. ft. to a 256 sq. ft. max area	64 sq. ft. max area; for each 1.25 ft. setback, add 3.55 sq. ft. to a 256 sq. ft. max area
Interstate Freeway	32 sq. ft. max area	128 sq. ft. max area	128 sq. ft. max area	128 sq. ft. max area; for each 2.00 ft. setback, add 10.65 sq. ft./ 288 max	128 sq. ft. max area; for each 2.00 ft. setback, add 10.65 sq. ft./ 288 max

- (ii) Arterial streets listed in Section 29-4.8(f)(1) shall be regulated by the collector street provisions of Table 4.8-9.
- (iii) Collector and local, non-residential streets listed in Section 29-4.8(f)(1) shall be regulated by the arterial street provisions of Table 4.8-9.
- (iv) The interstate and freeway category in Table 4.9-9 shall apply only to property within one hundred (100) feet of the right-of-way of Interstate 70 and U.S. 63 and property, either in whole or in part, within one thousand (1,000) feet of the midpoint of the intersections with Interstate 70 and U.S. 63.
- (v) Street classifications are defined by the Major Thoroughfare Plan of the City of Columbia and the Subdivision Regulations of the City of Columbia.
- (vi) Where increased sign area is allowed by reason of increased setback, the setback shall be measured from a point thirty-five (35) feet from the curb or, if there is no curb, then thirty-five (35) feet from the edge of the pavement.
- (vii) The surface area of any wall sign shall not exceed fifteen (15) percent of the area of the wall or twenty (20) percent of the area of the wall if the business does not have a freestanding sign.
- (viii) In any PD District that allows nonresidential uses, on-premises wall, canopy and awning sign surface area shall be subject to review and approval of development plans or final development plans. Specific regulations shall be recommended to and approved by the Council as part of a development plan or final development plan, or in the case of minor revisions, by the Commission or Director. Changes to specific sign regulations within a development plan shall only be approved through compliance with zoning ordinance procedures for review and approval of development plans and final development plans and changes to them.
- (ix) When an establishment has frontage on more than one street, the sign surface area for wall, canopy and awning signs shall be determined separately for each street.

29-4.9 Operation and Maintenance Standards.

29-4.9(a) - Maintenance Requirement.

(1) General.

When the standards and procedures of this Chapter or by conditions attached to any permit, approval, or variance require that any building or site feature be constructed or installed, the property owner is responsible for maintaining those building or site features in good repair, and for replacing them if they are damaged or destroyed or, in the case of living materials, if they become diseased or die after installation. In addition, property owners shall be responsible for each of the additional maintenance, replacement, and operating standards set forth in this Section 29-4.9.

(2) Landscape Maintenance.

- (i) The trees, shrubs, fences, walls and other landscaping materials depicted on approved plans shall be considered as elements of the project in the same manner as parking, building materials and other elements. The property owner and any agents who are authorized to maintain the property shall be responsible for the continued maintenance of those items. Plant material that exhibits evidence of insect pest disease or damage shall be appropriately treated, and dead plants promptly removed and replaced within the next planting season. All landscaping will be subject to periodic inspection by the City to ensure compliance.
- (ii) Any trees required to be installed by this Chapter that are lost to damage or disease within two (2) years after installation, shall be replaced by the property owner within six (6) months at a ratio of one (1) tree per one (1) inch of DBH lost. Replacement trees must be at least two (2) inch in caliper size. Shrubbery or other plantings that die within eighteen (18) months of installation shall be replaced in kind within six (6) months.

(3) Parking Area Maintenance.

All surface parking areas and parking structures shall be maintained in clean and neat condition. Potholes, surface damage, and other hazardous conditions shall be promptly repaired, and litter and debris shall be removed on a regular basis.

(4) Sign Maintenance.

- (i) Any private sign that has become damaged, dilapidated, or dangerous shall be immediately, or within the time frame mandated by the Director, repaired or removed. If the paint on any sign has checked, peeled, or flaked to the extent that the sign cannot be read in whole or in part, the sign shall be repainted or removed. Signs that contain messages that have become obsolete because of the termination of the use or business or product advertised, or for some other reason, shall have such message removed within sixty (60) days of its becoming obsolete.
- (ii) If maintenance to meet the standards in subsections (i) is neglected, the City shall notify the sign owner in writing of the type of maintenance required. If the maintenance is not provided within sixty (60) days, the City may revoke the permit and, confiscate the sign face, or take any other action authorized by Section 29-6.6 (Violations, Enforcement, and Penalties).

29-4.9(b) - Operating Standards.

All structures, uses, and activities in all Districts shall be used or occupied so as to avoid creating any dangerous, injurious, noxious or otherwise objectionable condition that would create adverse impacts on the residents, employees, or visitors on the property itself or on neighboring properties. Uses and activities that operate in violation of applicable state or federal statutes or this Chapter are presumed to be a violation of this Section 29-4.90. Property owner responsibilities under this section shall include, but shall not be limited to, the following standards:

(1) Glare.

Direct or reflected glare, including glare from exterior lighting, shall not be visible at the property line.

(2) Noise.

All activities shall comply with state statutes and be conducted so as to avoid the creation of any noise that would create a public nuisance or a nuisance interfering with the use and enjoyment of adjacent properties. Any amplified sound equipment shall be mounted so as to direct sounds inward from properties, rather than outward towards property boundaries. Amplified sounds shall not be allowed to cross property lines unless a temporary use permit has been issued for that purpose in connection with a special event.

(3) Odors.

All activities shall comply with state statutes and regulations. No operation shall cause or allow the emission of any odorous air contaminant that is a nuisance, hazard or exceeds applicable federal or state regulations. Detailed plans for the prevention of odors crossing property lines may be required before the issuance of a development or building permit.

(4) Smoke.

All activities shall comply with state statutes and regulations. No operation shall discharged into the atmosphere any contaminant for which threshold limit values are listed for working atmosphere by the American Conference of Governmental Industrial Hygienists in such quantity that the concentration of the contaminant at ground level at any point beyond the boundary of the property shall at any time exceed the threshold limit established by such conference or by any state or federal law or regulation. Visible emissions of any kind at ground level past the lot line of the property on which the source of the emissions is located are prohibited.

(5) Vibration.

No use or activity shall cause inherent and recurring generated vibration perceptible without instruments at any point along the property line. Temporary construction is excluded from this restriction.

(6) Hazardous Materials.

All uses and activities shall comply with state statutes and regulations regarding the use, storage, handling, and transportation of flammable liquids, liquefied petroleum, gases, explosives, hazardous materials, hazardous wastes, toxic materials and solid wastes, as those terms are defined by applicable statutes, rules, regulations, or ordinances.

(7) Materials and Waste Handling.

All materials or wastes that might cause fumes or dust or that constitute a fire hazard or that may be edible by or otherwise be attractive to rodents or insects shall be stored outdoors only in closed, impermeable trash containers that are screened in accordance with

the requirements of this Code. Lubrication and fuel substances shall be prevented from leaking and/or draining onto the ground. All sewage and industrial wastes shall be treated and disposed of in compliance with the water quality standards applicable of the state and federal government.

(8) Electromagnetic Radiation.

No use or activity shall create or operate an intentional source of electromagnetic radiation that does not comply with the then current regulations of the Federal Communications Commission regarding that type of electromagnetic radiation source. In case of governmental communications facilities, governmental agencies, and government owned plants, the regulations of the interdepartmental Radio Advisory Committee shall take precedence over the regulations of the Federal Communications Commission, regarding such sources of electromagnetic radiation.

(9) Nuclear Radiation.

No use or activity shall cause radiation at any property line that violates any regulation of the United States Nuclear Regulatory Commission.

(10) Nuisance Prohibited.

All structures and land uses within the City shall be constructed, used, operated, and maintained in such a manner so as to be free of nuisances, as defined in state law and by City Code.