

PRELIMINARY PLAT BENNETT RIDGE

LOCATED IN SECTION 35, TOWNSHIP 49 NORTH, RANGE 13 WEST
COLUMBIA, BOONE COUNTY, MISSOURI
JUNE 10, 2024

OWNER / DEVELOPER
YANKEE RIDGE LLC
305 E McCARTY ST, SUITE 300
JEFFERSON CITY, MO 65101

SITE DATA

CURRENT DEED = BOOK 5593, PAGE 104
SIZE OF TRACT = 52.15 ACRES.
CURRENT ZONING = A. PROPOSED ZONING = R-2.
PROPERTY IS CURRENTLY VACANT.
LOCATED IN SECTION 35, TOWNSHIP 49 NORTH, RANGE 13 WEST

PROPERTY DESCRIPTION

A TRACT OF LAND LOCATED IN THE SOUTHEAST QUARTER OF SECTION 35, TOWNSHIP 49 NORTH, RANGE 13 WEST, COLUMBIA, BOONE COUNTY, MISSOURI, BEING TRACT 1 AND TRACT 2 OF THE SURVEY RECORDED IN BOOK 5764, PAGE 100 AND DESCRIBED BY THE QUIT-CLAIM DEED RECORDED IN BOOK 5593, PAGE 104 AND CONTAINING 52.15 ACRES.

GENERAL NOTES

1. A MINIMUM TEN (10) FOOT UTILITY EASEMENT SHALL BE DEDICATED ALONG ALL STREETS.
2. ALL STREET RIGHT-OF-WAY WITHIN THE SUBDIVISION WILL BE 50' WIDE.
3. THE STREETS ARE PROPOSED TO BE 28' IN WIDTH.
4. ALL DRAINAGE STRUCTURES WILL HAVE A MINIMUM SIXTEEN (16') FOOT DRAINAGE EASEMENT PROVIDED.
5. A 42' HALF-WIDTH R/W WILL BE DEDICATED FROM THE EXISTING CENTERLINE OF THE EXISTING STREET EASEMENT RECORDED IN BOOK 698, PAGE 145.
6. THE SITE IS VACANT, THERE ARE NO EXISTING BUILDINGS ON THESE TRACTS.
7. CONTOUR INTERVAL IS FIVE (5) FEET.
8. LOCATIONS OF PROPOSED WATER LINES AND FIRE HYDRANTS WILL BE PROVIDED BY CITY OF COLUMBIA WATER & LIGHT DEPARTMENT.
9. THERE ARE TWO SMALL TRACTS LOCATED ON THE WEST SIDE OF THE CREAMY SPRINGS ROAD STREET EASEMENT RECORDED IN BOOK 698, PAGE 145. THESE TWO SMALL TRACT WILL BE DEDICATED AS RIGHT-OF-WAY.
10. LOTS 1-117 ARE INTENDED TO BE "COTTAGE" RESIDENTIAL DEVELOPMENT LOTS PER SECTION 29-2.2(g)(2) OF THE UNIFIED DEVELOPMENT CODE. A REQUEST WILL BE SUBMITTED TO THE BOARD OF ADJUSTMENT TO ALLOW COTTAGE STANDARDS. LOTS 1-118 ARE INTENDED TO BE SINGLE FAMILY USE.
11. LOT 121 MAY NOT BE SUBDIVIDED UNTIL AN ADDITIONAL ACCESS IS OBTAINED FOR THE TRACT.
12. SEE SHEET 2 OF 2 FOR LOT DIMENSIONS, APPROXIMATE STORM AND SANITARY SEWER.
13. THE DEVELOPMENT'S STORMWATER MANAGEMENT WILL BE ON LOT 120.
14. SIDEWALKS WILL BE REQUIRED ADJACENT TO ALL PUBLIC RIGHTS-OF-WAY.

STREAM BUFFER STATEMENT

THE TYPE I STREAM BUFFER LIMIT SHOWN ON THIS PLAT IS INTENDED TO COMPLY WITH THE STREAM BUFFER REQUIREMENTS OF ARTICLE X OF CHAPTER 12A OF THE CITY OF COLUMBIA'S CODE OF ORDINANCES. THERE SHALL BE NO CLEARING, GRADING, CONSTRUCTION OR DISTURBANCE OF VEGETATION WITHIN THE BUFFER EXCEPT AS SPECIFICALLY APPROVED BY THE CITY OF COLUMBIA, MISSOURI. U.S.G.S. QUADRANGLE MAP "COLUMBIA" WAS USED TO DETERMINE THE TYPE OF STREAM.

FLOOD PLAIN STATEMENT

PORTIONS OF THIS TRACT ARE LOCATED WITHIN ZONE AE AS SHOWN BY THE FEMA FLOOD INSURANCE RATE MAP, COMMUNITY PANEL NO. 29019C0280E, DATED APRIL 19, 2017. THE 1% CHANCE FLOOD PLAIN IS LOCATED AS SHOWN.

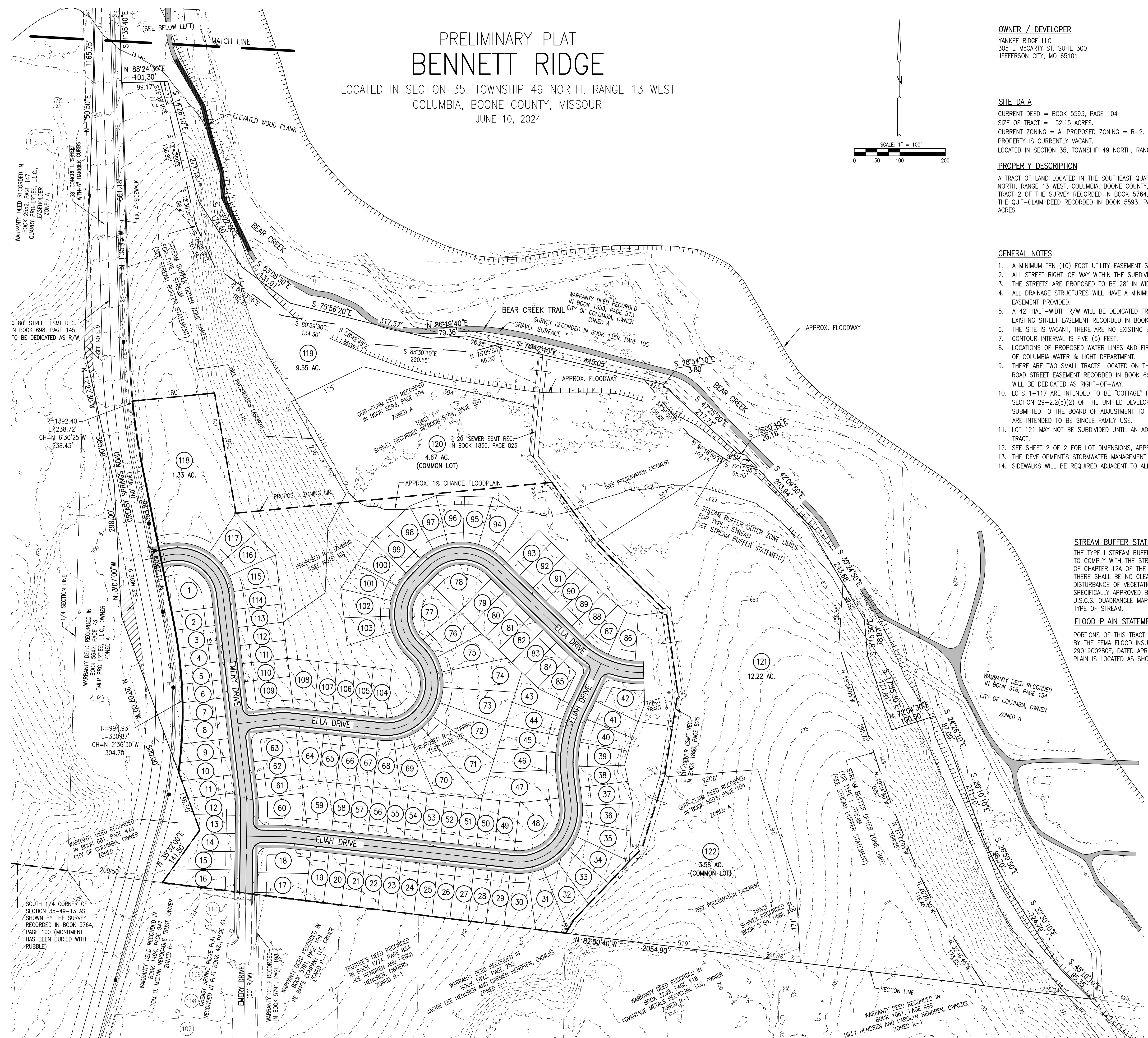
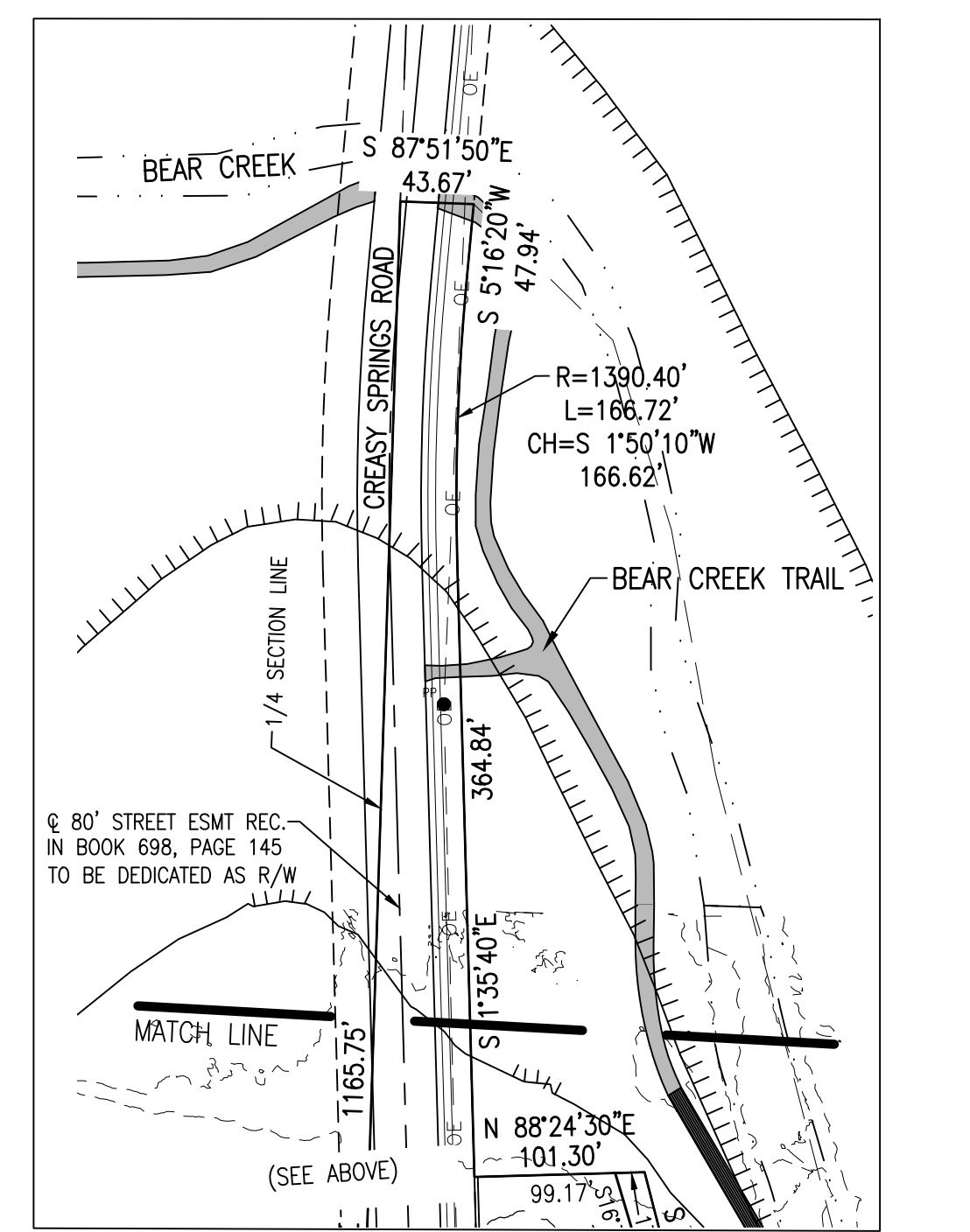
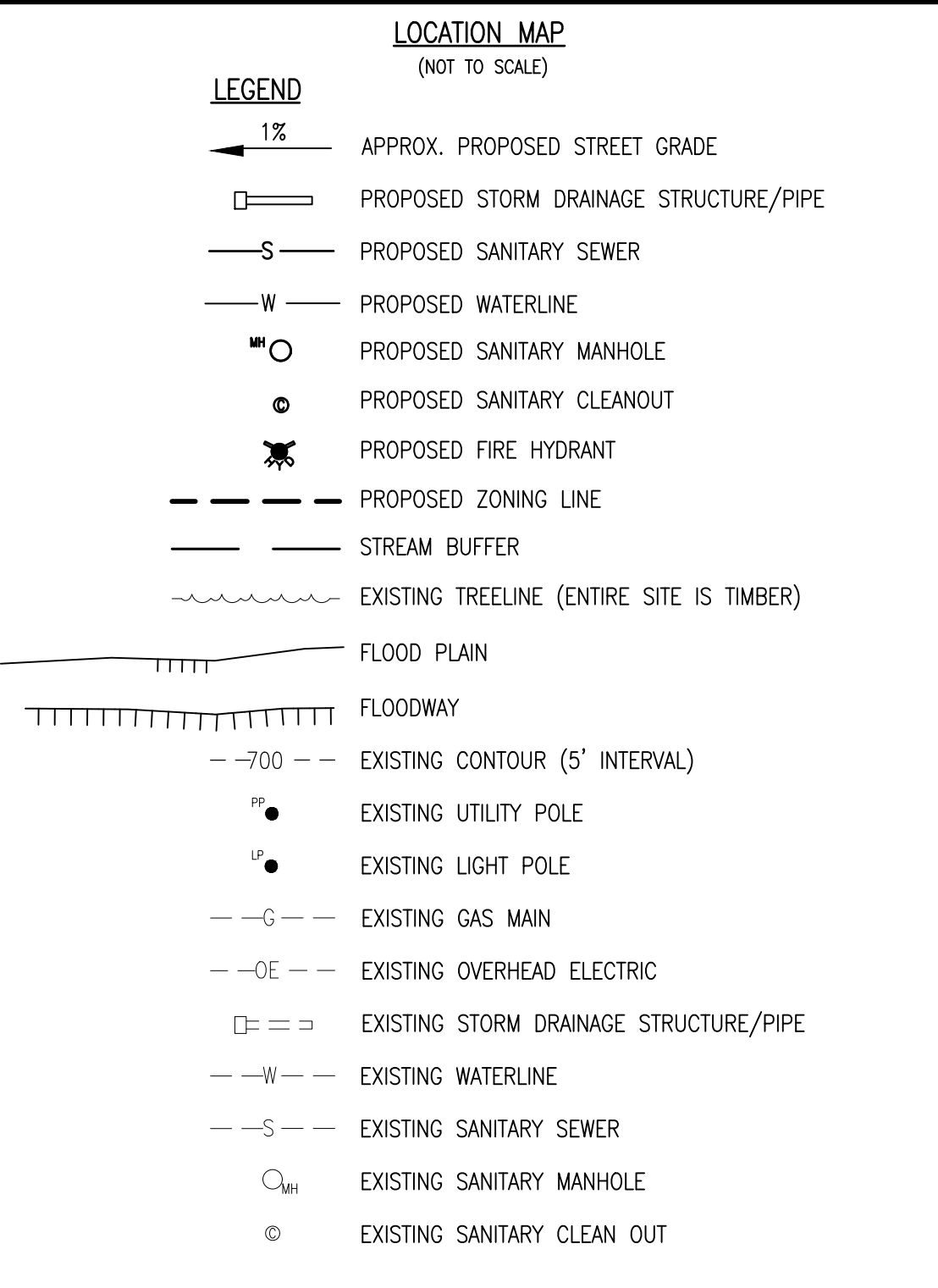
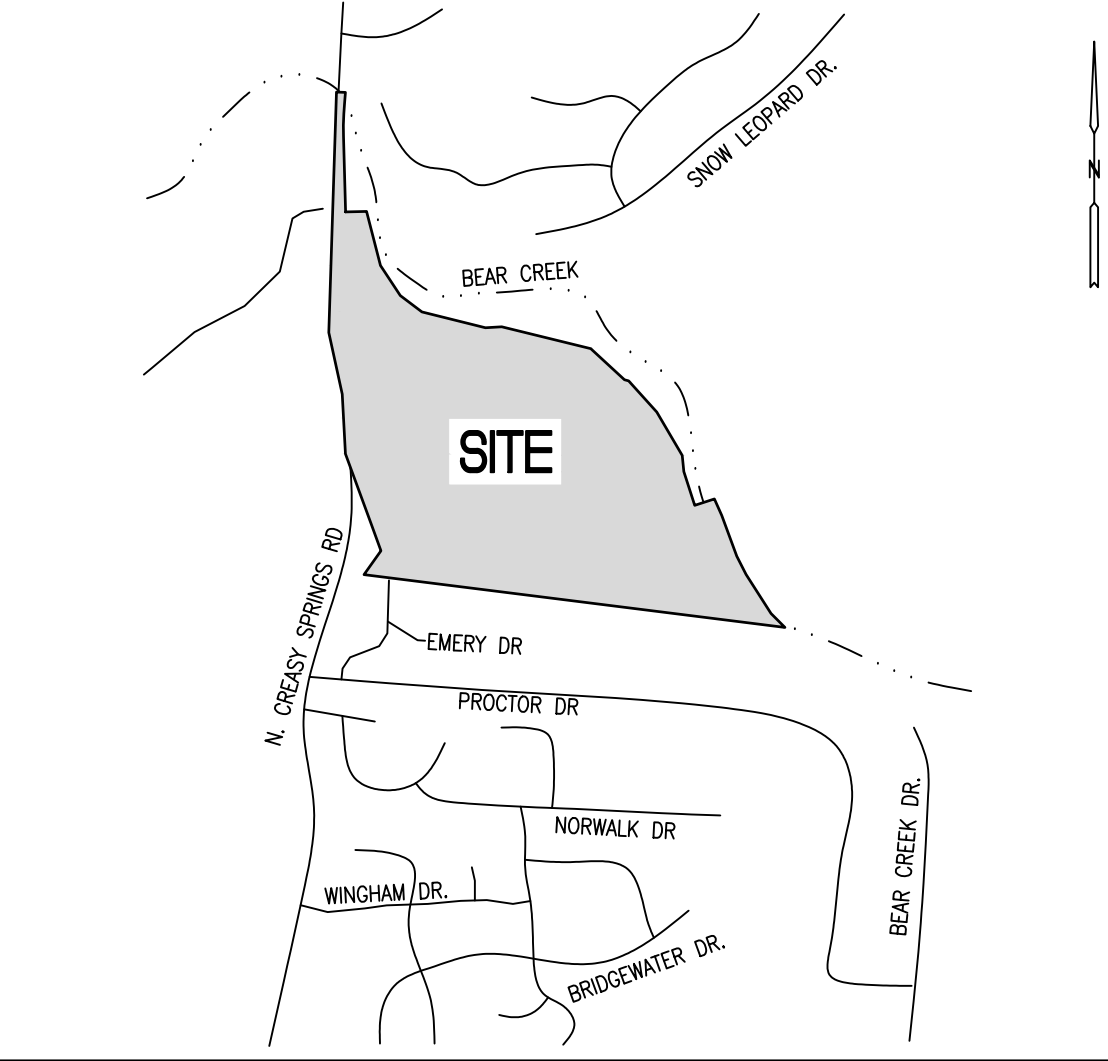
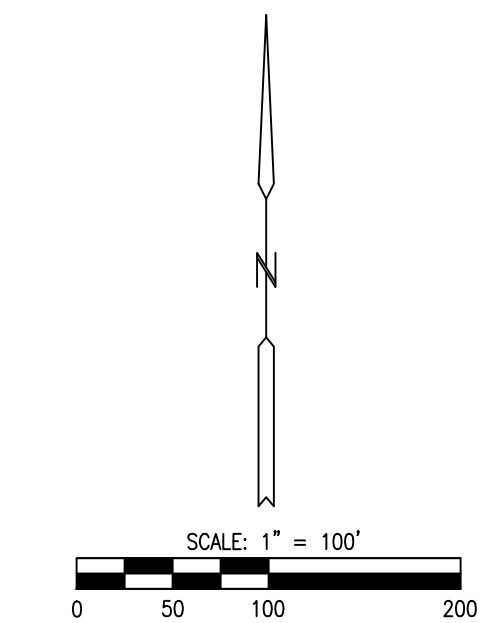

APPROVED BY THE CITY OF COLUMBIA PLANNING AND ZONING COMMISSION THIS ____ DAY OF _____, 2024.

SHARON GEUEA-JONES, CHAIRPERSON

JOB NUMBER
24021.01

7/1/2024

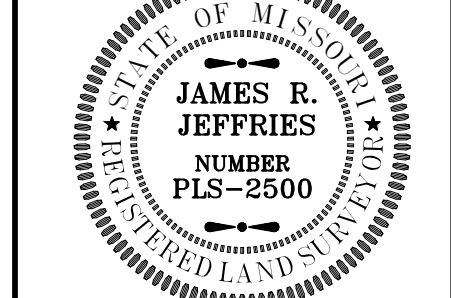

James R. Jeffries
JAMES R. JEFFRIES
PROFESSIONAL LAND SURVEYOR
PLS-2500

ALLSTATE CONSULTANTS
3312 LEMONE INDUSTRIAL BLVD.
COLUMBIA, MO 65201
(573) 875-8799
ALLSTATE CONSULTANTS LLC
MO PROFESSIONAL LAND SURVEYING
CERTIFICATE OF AUTHORITY #2007000167

PRELIMINARY PLAT BENNETT RIDGE

LOCATED IN SECTION 35, TOWNSHIP 49 NORTH, RANGE 13 WEST
COLUMBIA, BOONE COUNTY, MISSOURI
JUNE 10, 2024

JOB NUMBER: 24021.01
PRELIMINARY PLAT - BENNETT RIDGE

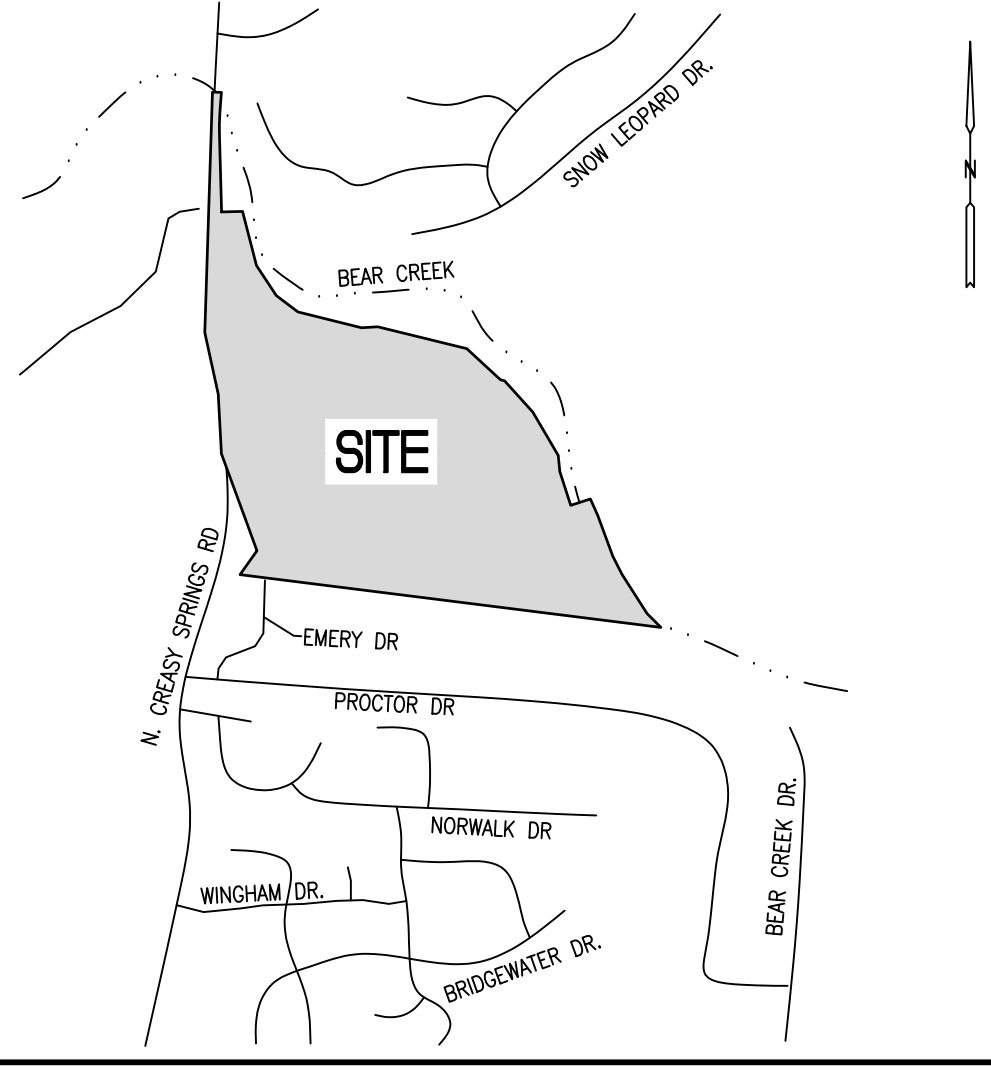

LOCATION MAP
(NOT TO SCALE)

LEGEND

- APPROX. PROPOSED STREET GRADE
- PROPOSED STORM DRAINAGE STRUCTURE/PIPE
- PROPOSED SANITARY SEWER
- PROPOSED WATERLINE
- PROPOSED SANITARY MANHOLE
- PROPOSED SANITARY CLEANOUT
- PROPOSED FIRE HYDRANT
- PROPOSED ZONING LINE
- STREAM BUFFER
- EXISTING TREELINE (ENTIRE SITE IS TIMBER)
- FLOOD PLAIN
- FLOODWAY
- EXISTING CONTOUR (5' INTERVAL)
- EXISTING UTILITY POLE
- EXISTING LIGHT POLE
- EXISTING GAS MAIN
- EXISTING OVERHEAD ELECTRIC
- EXISTING STORM DRAINAGE STRUCTURE/PIPE
- EXISTING WATERLINE
- EXISTING SANITARY SEWER
- EXISTING SANITARY MANHOLE
- EXISTING SANITARY CLEANOUT

EXISTING UTILITIES

CITY OF COLUMBIA ELECTRIC

EXISTING FACILITIES
3 PHASE OVERHEAD ALONG WEST SIDE OF PROPERTY (EAST SIDE OF CREEPY SPRINGS RD.)
SINGLE PHASE UNDERGROUND AT END OF EMERY DRIVE AT SOUTH PROPERTY LINE

CITY OF COLUMBIA WATER

EXISTING WATER MAINS
8" PVC ON EAST SIDE OF CREEPY SPRINGS ROAD, SOUTH OF THE PROPERTY
6" PVC ON WEST SIDE OF EMERY DRIVE SOUTH OF THE PROPERTY
6" PVC ON SOUTH SIDE OF PRAIRIEVIEW DRIVE TO THE NORTH OF THE PROPERTY

AMEREN (NATURAL GAS)

EXISTING 8" MAIN ALONG NORTH SIDE OF BERNADETTE DR.
EXISTING 8" MAIN ALONG WEST SIDE OF N. FAIRVIEW RD.

CITY OF COLUMBIA SANITARY SEWER

EXISTING GRAVITY SANITARY SEWER LINE IS LOCATED THROUGH THE TRACT (8" PVC)

APPROVED BY THE CITY OF COLUMBIA PLANNING AND ZONING COMMISSION THIS _____ DAY OF _____, 2024.

SHARON GEUEA-JONES, CHAIRPERSON

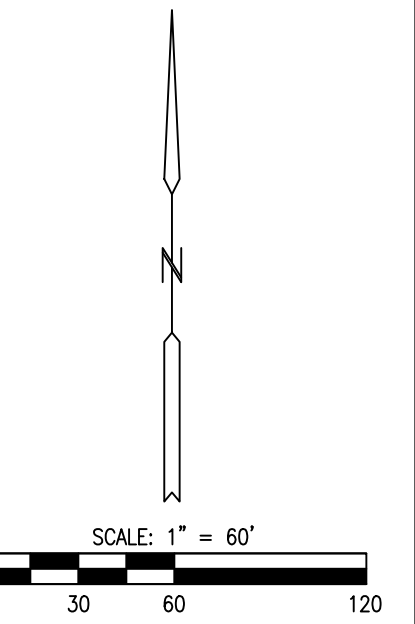
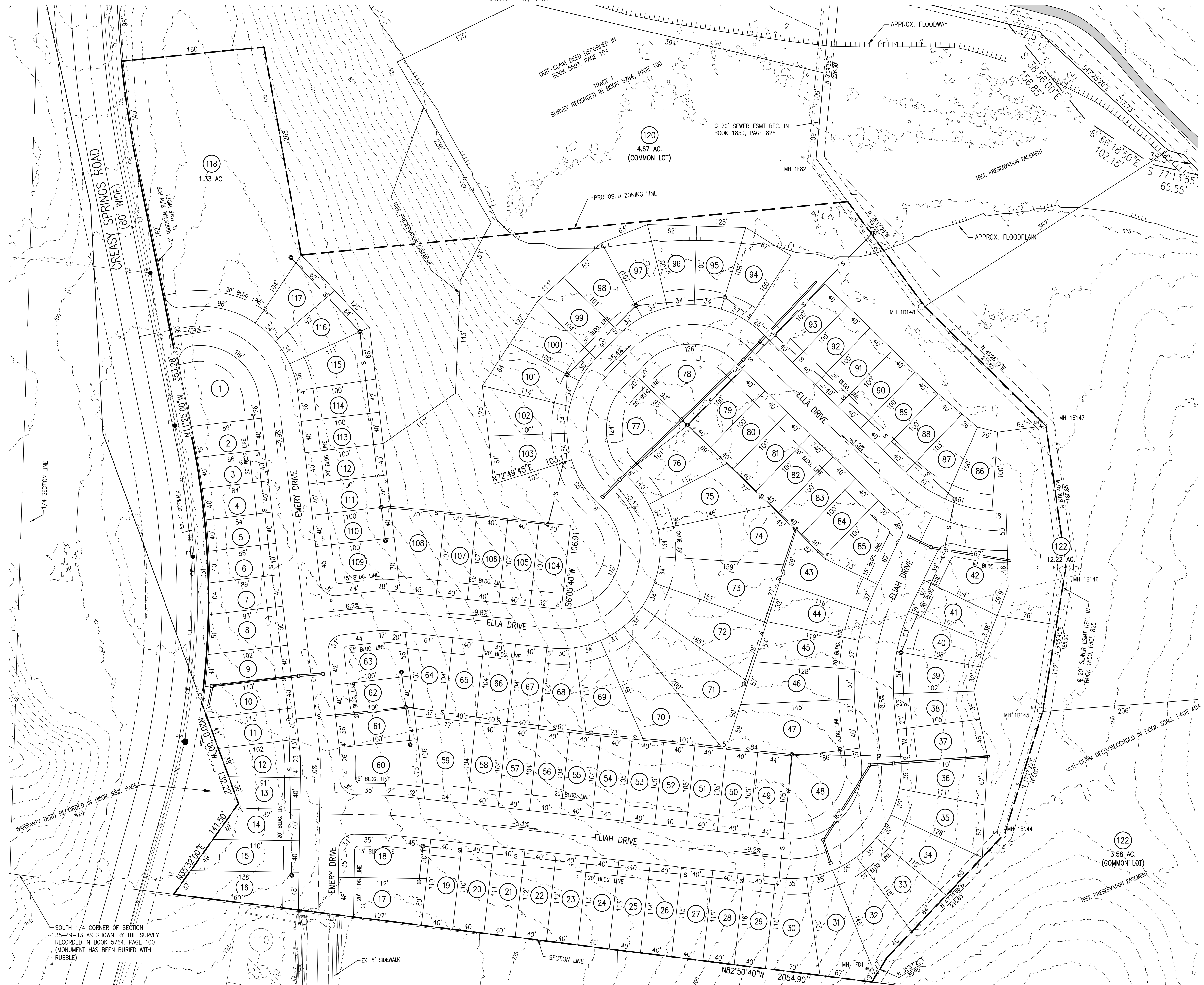

JOB NUMBER
24021.01

7/1/2024

James R. Jeffries
JAMES R. JEFFRIES
PROFESSIONAL LAND SURVEYOR
PLS-2500

ALLSTATE CONSULTANTS
3312 LEMONE INDUSTRIAL BLVD.
COLUMBIA, MO 65201
(573) 875-8799
ALLSTATE CONSULTANTS LLC
MO PROFESSIONAL LAND SURVEYING
CERTIFICATE OF AUTHORITY #2007000167

SHEET 2 OF 2