

PRELIMINARY PLAT RICHLAND ESTATES

A MAJOR SUBDIVISION LOCATED IN SECTION 14,
TOWNSHIP 48 NORTH, RANGE 12 WEST
COLUMBIA, BOONE COUNTY, MISSOURI
FEBRUARY 13, 2023

OWNER:
CHARLOTTE M. FRAZIER & MELISSA L. USSERY
10950 STATE RTE PP
WESTPLAINS, MO 65775

OWNER/DEVELOPER:
RICHLAND OLIVET FARM, L.L.C.
4240 PHILIPS FARM RD SUITE 109
COLUMBIA, MO 65201

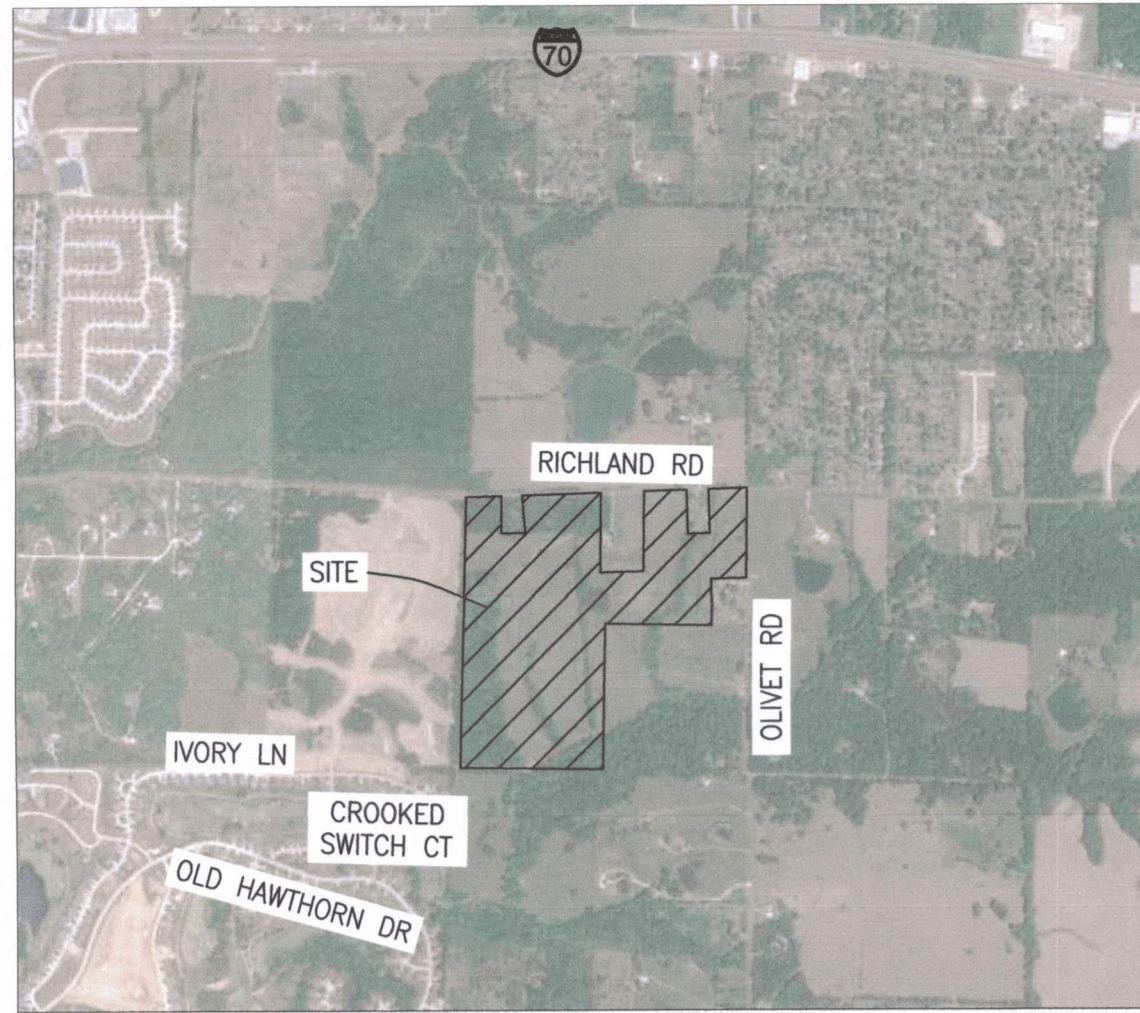

LOCATION MAP
NOT TO SCALE

BEARINGS ARE REFERENCED TO GRID NORTH, OF THE MISSOURI STATE PLANE COORDINATE SYSTEM (CENTRAL ZONE), OBTAINED FROM GPS OBSERVATION.

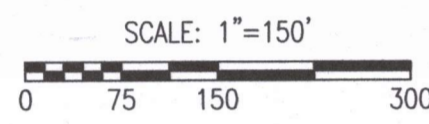

LEGEND:

- EXISTING MINOR CONTOUR
- EXISTING MAJOR CONTOUR
- CURB
- EXISTING SANITARY SEWER
- PROPOSED SANITARY SEWER
- MANHOLE/CLEANOUT
- PROPOSED WATERLINE
- PROPOSED LIGHT POLE
- PROPOSED FIRE HYDRANT
- EXISTING STORM SEWER
- PROPOSED STORM SEWER
- BUILDING LINE
- EASEMENT
- LOT NUMBER
- PROPOSED PAVEMENT
- PROPOSED DETENTION
- EXISTING TREELINE
- SECTION LINE
- FLOODPLAIN
- TYPE II STREAM BUFFER

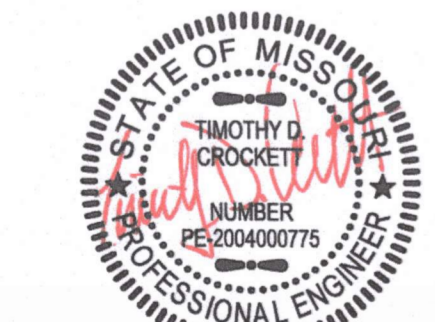

4/17/2023
TIMOTHY D. CROCKETT - PE-2004000775

APPROVED BY THE CITY OF COLUMBIA PLANNING AND ZONING COMMISSION, THIS 4th DAY OF May, 2023.

SHARON GEUEA JONES, CHAIRPERSON

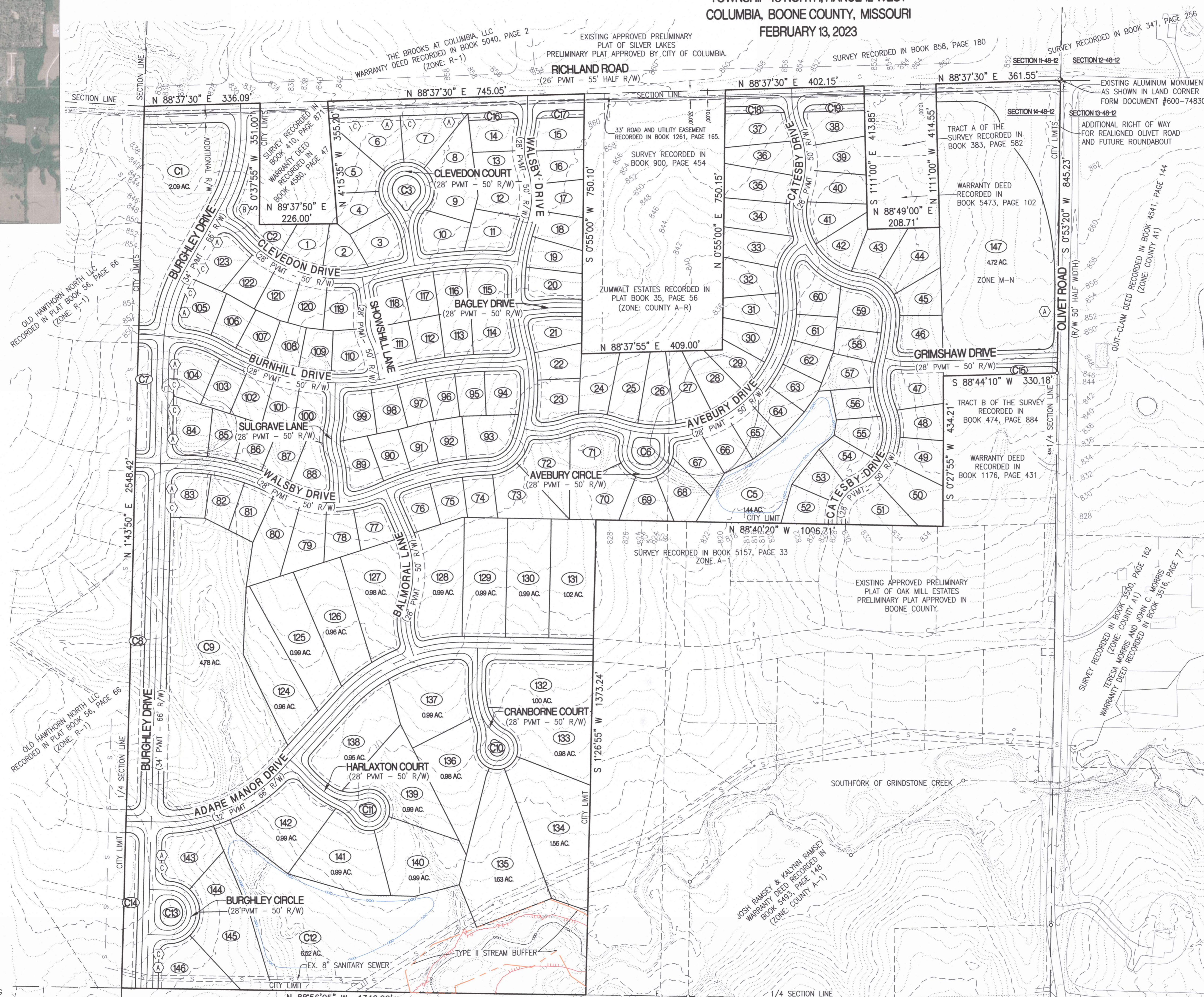

CERTIFICATION:

THREE TRACTS OF LAND LOCATED IN THE NORTHEAST QUARTER OF SECTION 14, TOWNSHIP 48 NORTH, RANGE 12 WEST, COLUMBIA, BOONE COUNTY, MISSOURI AND BEING DESCRIBED BY TRUSTEE'S DEED RECORDED IN BOOK 5670, PAGE 52 AND BOOK 5199, PAGE 75 AND BEING MORE PARTICULARLY DESCRIBED AS FOLLOWS: BEGINNING AT THE SOUTHWEST CORNER OF THE NORTHEAST QUARTER OF SAID SECTION 14 AND WITH THE WEST LINE THEREOF, N 1'43'50"E, 2548.42 FEET TO THE NORTHWEST CORNER OF THE NORTHEAST QUARTER OF SAID SECTION 14; THENCE LEAVING SAID WEST LINE AND WITH THE NORTH LINE OF SAID SECTION 14, N 88'37'30"E, 336.09 FEET TO THE NORTHWEST CORNER OF TRACT B OF THE SURVEY RECORDED IN BOOK 410, PAGE 871 AND DESCRIBED IN WARRANTY DEED RECORDED IN BOOK 4580, PAGE 47; THENCE WITH THE WEST LINE OF SAID TRACT B, S 0'37'55"W, 351.00 FEET TO THE SOUTHWEST CORNER OF SAID TRACT B; THENCE LEAVING SAID WEST LINE AND WITH THE SOUTH LINE OF SAID TRACT B, N 89'37'50"E, 226.00 FEET TO THE SOUTHWEST CORNER OF SAID TRACT B; THENCE LEAVING SAID SOUTH LINE AND WITH THE EAST LINE OF SAID TRACT B, N 4'15'35"W, 355.20 FEET TO THE NORTH LINE OF SAID SECTION 14; THENCE LEAVING SAID EAST LINE AND WITH SAID NORTH LINE, N 88'37'30"E, 745.05 FEET TO THE NORTHWEST CORNER OF A TRACT OF LAND AS SHOWN IN SURVEY RECORDED IN BOOK 900, PAGE 454; THENCE LEAVING SAID NORTH LINE AND WITH THE WEST LINE OF SAID TRACT, S 0'55'00"E, 750.10 FEET TO THE SOUTHWEST CORNER OF SAID TRACT; THENCE LEAVING SAID WEST LINE AND WITH THE SOUTH LINE OF SAID TRACT, N 88'37'55"E, 409.00 FEET TO THE SOUTHWEST CORNER OF SAID TRACT; THENCE LEAVING SAID SOUTH LINE AND WITH THE EAST LINE OF SAID TRACT, N 0'55'00"E, 750.15 FEET TO THE NORTHEAST CORNER OF SAID TRACT, SAID POINT BEING ON SAID NORTH LINE OF SECTION 14; THENCE LEAVING SAID EAST LINE AND WITH SAID NORTH LINE, N 88'37'30"E, 402.15 FEET TO THE NORTHWEST CORNER OF TRACT A OF THE SURVEY RECORDED IN BOOK 383, PAGE 582 AND DESCRIBED IN WARRANTY DEED RECORDED IN BOOK 5473, PAGE 102; THENCE LEAVING SAID NORTH LINE AND WITH THE WEST LINE OF SAID TRACT A, N 88'49'00"E, 413.85 FEET TO THE SOUTHWEST CORNER OF SAID TRACT A; THENCE LEAVING SAID WEST LINE AND WITH THE SOUTH LINE OF SAID TRACT A, S 1'11'00"E, 413.85 FEET TO THE SOUTHWEST CORNER OF SAID TRACT A; THENCE LEAVING SAID WEST LINE AND WITH THE SOUTH LINE OF SAID TRACT A, N 88'49'00"E, 208.71 FEET TO THE SOUTHWEST CORNER OF SAID TRACT A; SAID POINT BEING ON SAID NORTH LINE OF SECTION 14; THENCE LEAVING SAID EAST LINE AND WITH SAID NORTH LINE, N 88'37'30"E, 361.55 FEET TO THE NORTHEAST CORNER OF THE NORTHEAST QUARTER OF SAID SECTION 14; THENCE LEAVING SAID NORTH LINE AND WITH THE EAST LINE OF SAID SECTION 14, S 0'53'20"W, 845.23 FEET TO THE NORTHEAST CORNER OF TRACT B OF THE SURVEY RECORDED IN BOOK 474, PAGE 884 AS DESCRIBED IN WARRANTY DEED RECORDED IN BOOK 1176, PAGE 431; THENCE LEAVING SAID EAST LINE AND WITH THE NORTH LINE OF SAID TRACT B, S 88'44'10"W, 330.18 FEET TO THE NORTHWEST CORNER OF SAID TRACT B; THENCE LEAVING SAID NORTH LINE AND WITH THE WEST LINE OF SAID TRACT B, S 0'27'55"W, 434.21 FEET TO THE SOUTHWEST CORNER OF SAID TRACT B; THENCE LEAVING SAID WEST LINE, N 88'40'20"W, 1006.71 FEET TO THE WEST LINE OF THE EAST HALF OF SAID NORTHEAST QUARTER; THENCE WITH SAID WEST LINE, S 1'26'55"W, 1373.24 FEET TO THE SOUTH LINE OF THE NORTHEAST QUARTER OF SAID SECTION 14; THENCE LEAVING SAID WEST LINE AND WITH SAID SOUTH LINE, N 88'56'05"W, 1346.90 FEET TO THE POINT OF BEGINNING AND CONTAINING 103.73 ACRES.

NOTES:

1. A PORTION OF THIS TRACT IS LOCATED WITHIN ZONE AE AS SHOWN ON THE FEMA F.I.R.M. PANEL #29019C0305E, DATED APRIL 19, 2017.
2. REGULATED STREAM BUFFER EXISTS ON THIS TRACT AND IS REGULATED BY THE STREAM BUFFER REQUIREMENTS IN SECTION 12A-230, ARTICLE X OF THE CITY OF COLUMBIA CODE OF ORDINANCES AS SHOWN BY THE MILLERSBURG USGS QUADRANGLE MAP.
3. THE STREET R/W SHALL BE 50 FOOT WIDE, UNLESS OTHERWISE NOTED.
4. THERE SHALL BE A 10 FOOT UTILITY EASEMENT ALONG THE SIDE OF EACH LOT ADJACENT TO STREET RIGHT-OF-WAY.
5. WATER DISTRIBUTION TO BE PROVIDED BY PWS# #9.
6. ELECTRIC DISTRIBUTION TO BE DESIGNED BY THE BOONE ELECTRIC COOPERATIVE.
7. NATURAL GAS DISTRIBUTION TO BE DESIGNED BY AMEREN.
8. LOT NUMBERS SHOWN ARE FOR INVENTORY PURPOSES ONLY.
9. THE EXISTING ZONING OF THIS TRACT IS R-1 AND M-N.
10. THIS PLAT CONTAINS 103.73 ACRES.
11. THE INTENT FOR THIS DEVELOPMENT IS TO BE DEVELOPED IN, MULTIPLE PHASES; HOWEVER DEVELOPING IT IN ONE SINGLE PHASE WOULD BE ALLOWED.
12. ALL STORM SEWER AND WATER QUALITY DESIGN SHALL MEET THE CITY OF COLUMBIA STORM WATER MANUAL AND DESIGN REGULATIONS.
13. THERE SHALL BE NO DIRECT ACCESS FROM ANY LOT ONTO BURGHLEY DRIVE, RICHLAND ROAD, OR OLIVET ROAD WITH THE EXCEPTION OF LOT 147 WHICH MAY HAVE ACCESS TO OLIVET ROAD WITH APPROVAL FROM BOONE COUNTY RESOURCE MANAGEMENT.
14. AT THE TIME OF PLATTING AN ACCESS EASEMENT SHALL BE GRANTED ACROSS LOT C2 TO PROVIDE ACCESS FROM TRACT B OF THE SURVEY RECORDED IN BOOK 410, PAGE 871 TO BURGHLEY DRIVE AND/OR CLEVELDON DRIVE. EXACT LOCATION OF EASEMENT TO BE DETERMINED BY THE DEVELOPER AND APPROVED BY THE CITY.
15. PER 29-4.4(d)(4) - LOTS THAT CONTAIN DETACHED OR ATTACHED RESIDENCES AND WHICH HAVE SIDE OR REAR PROPERTY BOUNDARIES ADJUTING COLLECTOR OR ARTERIAL STREET RIGHT-OF-WAY SHALL HAVE SCREENING EITHER ALONG SUCH BOUNDARIES OR AROUND ANY PATIOS ON THE LOT WHICH ARE VISIBLE FROM THE RIGHT-OF-WAY.

OLD HAWTHORNE PLAT NO. 5 RECORDED IN PLAT BOOK 41, PAGE 38

JOHN C. WRUZIK & NANCY J. ROSSON WARRANTY DEED RECORDED IN BOOK 3631, PAGE 61 (ZONE: COUNTY A-1)

PRELIMINARY PLAT RICHLAND ESTATES

A MAJOR SUBDIVISION LOCATED IN SECTION 14,
TOWNSHIP 48 NORTH, RANGE 12 WEST
COLUMBIA, BOONE COUNTY, MISSOURI
FEBRUARY 13, 2023

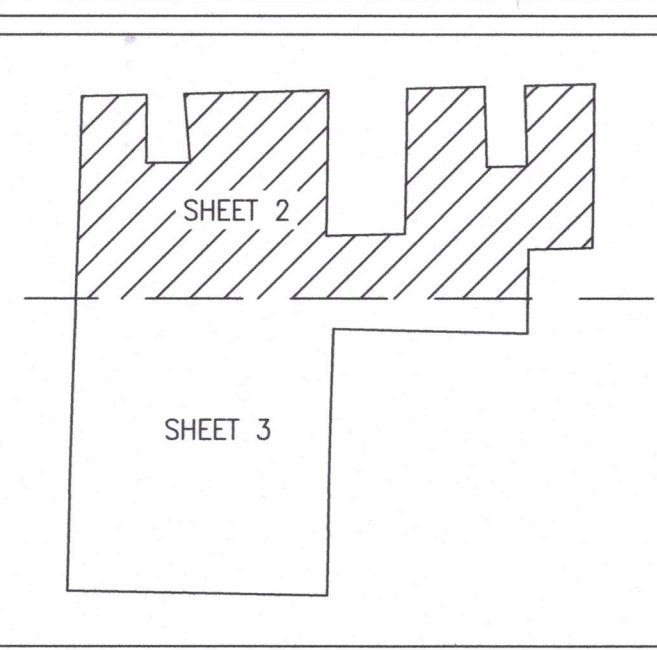

SHEET INDEX

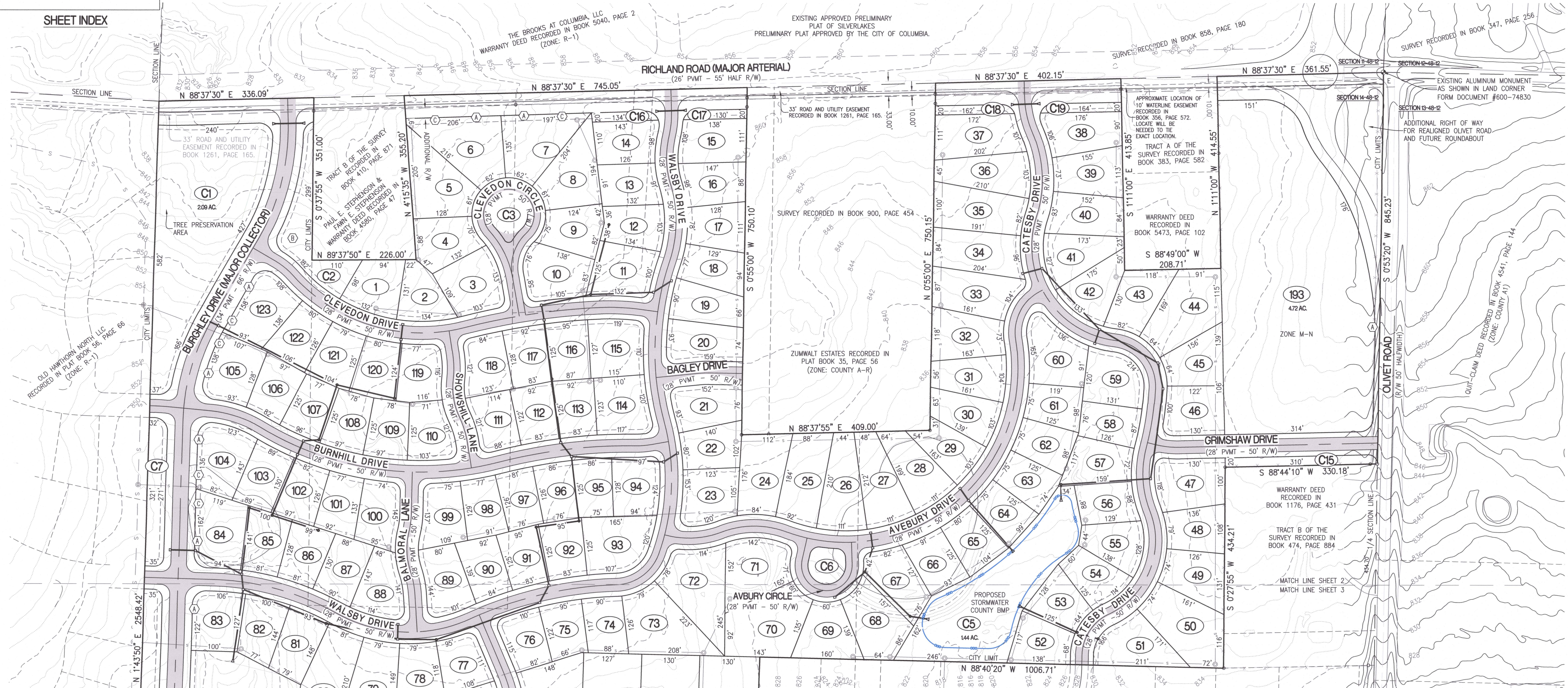

LEGEND:

--- 805 ---	EXISTING MINOR CONTOUR	--- 28' ---	EXISTING STORM SEWER
--- 820 ---	EXISTING MAJOR CONTOUR	--- 28' ---	PROPOSED STORM SEWER
---	CURB	---	BUILDING LINE
---	EXISTING SANITARY SEWER	---	EASEMENT
---	PROPOSED SANITARY SEWER	XX	LOT NUMBER
○	MANHOLE/CLEANOUT	---	PROPOSED PAVEMENT
---	PROPOSED WATERLINE	---	PROPOSED DETENTION
---	PROPOSED LIGHT POLE	---	EXISTING TREELINE
---	PROPOSED FIRE HYDRANT	---	SECTION LINE
---	FLOODPLAIN		
---	TYPE II STREAM BUFFER		

BEARINGS ARE REFERENCED TO GRID NORTH, OF THE MISSOURI STATE PLANE COORDINATE SYSTEM (CENTRAL ZONE), OBTAINED FROM GPS OBSERVATION.

SCALE: 1"=100'

0 50 100 200

OWNER:
CHARLOTTE M. FRAZIER &
MELISSA L. USSERY
10950 STATE RTE PP
WEST PLAINS, MO 65775

OWNER/DEVELOPER:
RICHLAND OLIVET FARM L.L.C.
4220 PHILIPS FARM RD.
COLUMBIA, MO 65201

- NOTES:**
- A PORTION OF THIS TRACT IS LOCATED WITHIN ZONE AE AS SHOWN ON THE FEMA F.I.R.M. PANEL #29019C0305E, DATED APRIL 19, 2017.
 - REGULATED STREAM BUFFER EXISTS ON THIS TRACT AND IS REGULATED BY THE STREAM BUFFER REQUIREMENTS IN SECTION 12A-230, ARTICLE X OF THE CITY OF COLUMBIA CODE OF ORDINANCES AS SHOWN BY THE MILLERSBURG USGS QUADRANGLE MAP.
 - THE STREET R/W SHALL BE 50 FOOT WIDE, UNLESS OTHERWISE NOTED.
 - THERE SHALL BE A 10 FOOT UTILITY EASEMENT ALONG THE SIDE OF EACH LOT ADJACENT TO STREET RIGHT-OF-WAY.
 - WATER DISTRIBUTION TO BE PROVIDED BY PWS# #9.
 - ELECTRIC DISTRIBUTION TO BE DESIGNED BY THE BOONE ELECTRIC COOPERATIVE.
 - NATURAL GAS DISTRIBUTION TO BE DESIGNED BY AMEREN.
 - LOT NUMBERS SHOWN ARE FOR INVENTORY PURPOSES ONLY.
 - THE EXISTING ZONING OF THIS TRACT IS R-1 AND M-N.
 - THIS PLAT CONTAINS 103.73 ACRES.
 - THE INTENT FOR THIS DEVELOPMENT IS TO BE DEVELOPED IN, MULTIPLE PHASES. HOWEVER DEVELOPING IT IN ONE SINGLE PHASE WOULD BE ALLOWED.
 - ALL STORM SEWER AND WATER QUALITY DESIGN SHALL MEET THE CITY OF COLUMBIA STORM WATER MANUAL AND DESIGN REGULATIONS.
 - THERE SHALL BE NO DIRECT ACCESS FROM ANY LOT ONTO BURGHLEY DRIVE, RICHLAND ROAD, OR OLIVET ROAD WITH THE EXCEPTION OF LOT 147 WHICH MAY HAVE ACCESS ONTO OLIVET ROAD WITH APPROVAL FROM BOONE COUNTY RESOURCE MANAGEMENT.
 - AT THE TIME OF PLATING AN ACCESS EASEMENT SHALL BE GRANTED ACROSS LOT C2 TO PROVIDE ACCESS FROM TRACT B OF THE SURVEY RECORDED IN BOOK 410, PAGE 871 TO BURGHLEY DRIVE AND/OR CLEVEDON DRIVE. EXACT LOCATION OF EASEMENT TO BE DETERMINED BY THE DEVELOPER AND APPROVED BY THE CITY.
 - PER 29-4.4(d)(4) - LOTS THAT CONTAIN DETACHED OR ATTACHED RESIDENCES AND WHICH HAVE SIDE OR REAR PROPERTY BOUNDARIES ADJUTING COLLECTOR OR ARTERIAL STREET RIGHT-OF-WAY SHALL HAVE SCREENING EITHER ALONG SUCH BOUNDARIES OR AROUND ANY PATIOS ON THE LOT WHICH ARE VISIBLE FROM THE RIGHT-OF-WAY.

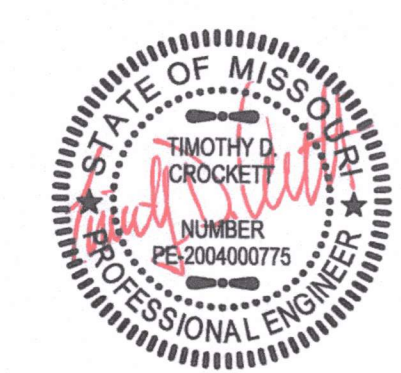

4/17/2023
TIMOTHY D. CROCKETT - PE-2004000775

PRELIMINARY PLAT RICHLAND ESTATES

A MAJOR SUBDIVISION LOCATED IN SECTION 14,
TOWNSHIP 48 NORTH, RANGE 12 WEST
COLUMBIA, BOONE COUNTY, MISSOURI
FEBRUARY 13, 2023



4/17/2023
TIMOTHY D. CROCKETT - PE-2004000775

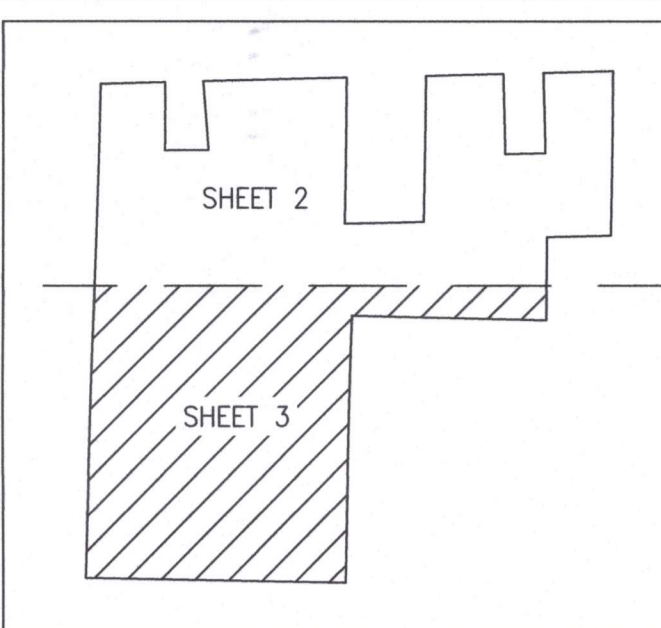

SHEET INDEX

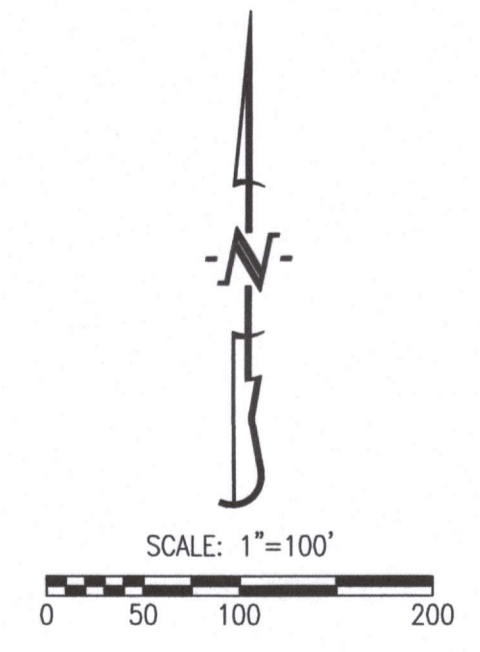
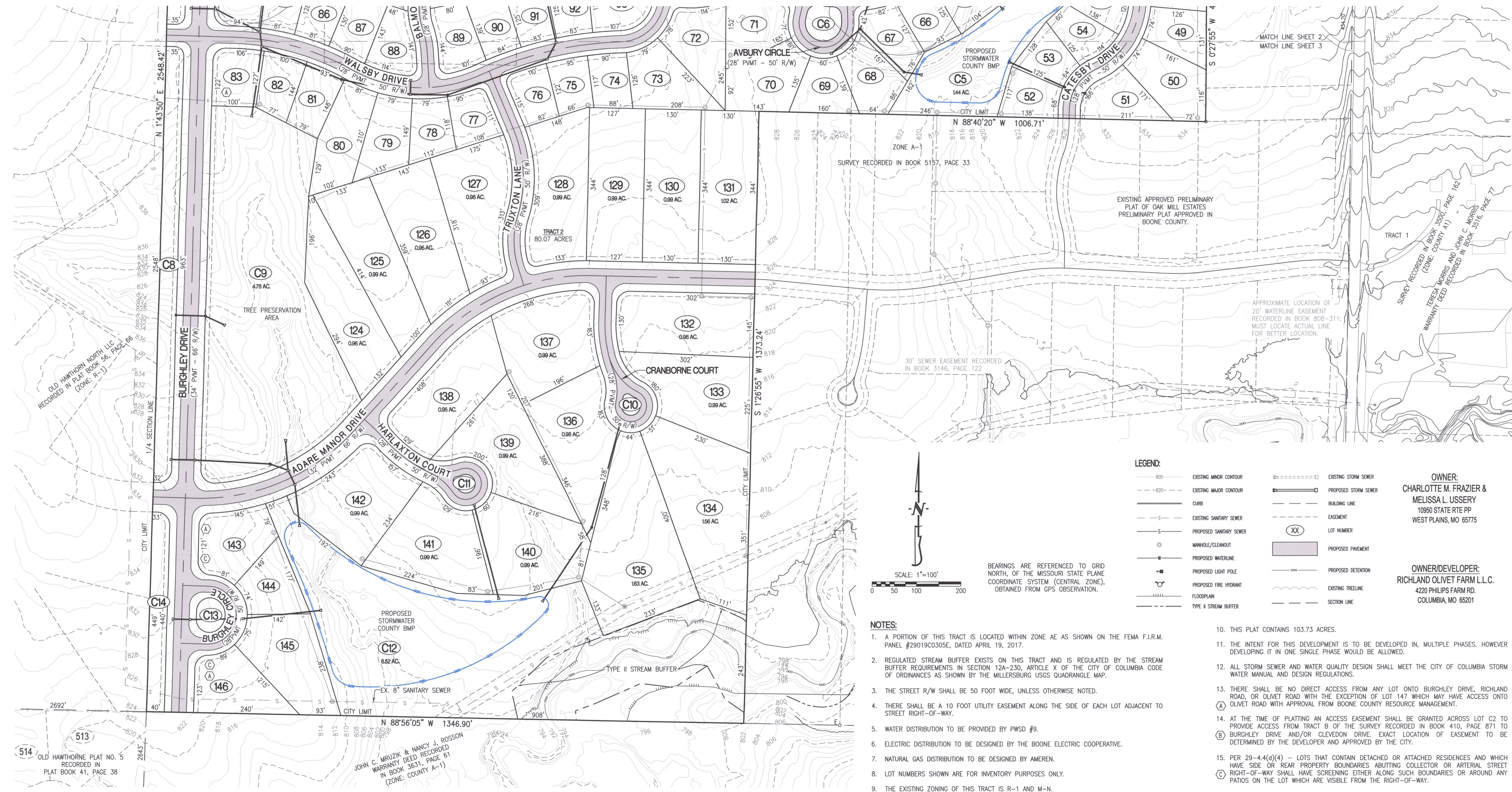

BEARINGS ARE REFERENCED TO GRID NORTH, OF THE MISSOURI STATE PLANE COORDINATE SYSTEM (CENTRAL ZONE), OBTAINED FROM GPS OBSERVATION.

LEGEND:

EXISTING MINOR CONTOUR	EXISTING STORM SEWER
EXISTING MAJOR CONTOUR	PROPOSED STORM SEWER
CURB	BUILDING LINE
EXISTING SANITARY SEWER	EASEMENT
PROPOSED SANITARY SEWER	LOT NUMBER
MANHOLE/CLEANOUT	PROPOSED PAVEMENT
PROPOSED WATERLINE	PROPOSED DETENTION
PROPOSED LIGHT POLE	EXISTING TREELINE
PROPOSED FIRE HYDRANT	SECTION LINE
FLOODPLAIN	
TYPE II STREAM BUFFER	

OWNER:
CHARLOTTE M. FRAZIER &
MELISSA L. USSERY
10950 STATE RTE PP
WEST PLAINS, MO 65775

OWNER/DEVELOPER:
RICHLAND OLIVET FARM L.L.C.
4220 PHILIPS FARM RD.
COLUMBIA, MO 65201

NOTES:

- A PORTION OF THIS TRACT IS LOCATED WITHIN ZONE AE AS SHOWN ON THE FEMA F.I.R.M. PANEL #29019C0305E, DATED APRIL 19, 2017.
- REGULATED STREAM BUFFER EXISTS ON THIS TRACT AND IS REGULATED BY THE STREAM BUFFER REQUIREMENTS IN SECTION 12A-230, ARTICLE X OF THE CITY OF COLUMBIA CODE OF ORDINANCES AS SHOWN BY THE MILLERSBURG USGS QUADRANGLE MAP.
- THE STREET R/W SHALL BE 50 FOOT WIDE, UNLESS OTHERWISE NOTED.
- THERE SHALL BE A 10 FOOT UTILITY EASEMENT ALONG THE SIDE OF EACH LOT ADJACENT TO STREET RIGHT-OF-WAY.
- WATER DISTRIBUTION TO BE PROVIDED BY PWS# 9.
- ELECTRIC DISTRIBUTION TO BE DESIGNED BY THE BOONE ELECTRIC COOPERATIVE.
- NATURAL GAS DISTRIBUTION TO BE DESIGNED BY AMEREN.
- LOT NUMBERS SHOWN ARE FOR INVENTORY PURPOSES ONLY.
- THE EXISTING ZONING OF THIS TRACT IS R-1 AND M-N.
- THIS PLAT CONTAINS 103.73 ACRES.
- THE INTENT FOR THIS DEVELOPMENT IS TO BE DEVELOPED IN, MULTIPLE PHASES. HOWEVER DEVELOPING IT IN ONE SINGLE PHASE WOULD BE ALLOWED.
- ALL STORM SEWER AND WATER QUALITY DESIGN SHALL MEET THE CITY OF COLUMBIA STORM WATER MANUAL AND DESIGN REGULATIONS.
- THERE SHALL BE NO DIRECT ACCESS FROM ANY LOT ONTO BURGHLEY DRIVE, RICHLAND ROAD, OR OLIVET ROAD WITH THE EXCEPTION OF LOT 147 WHICH MAY HAVE ACCESS ONTO OLIVET ROAD WITH APPROVAL FROM BOONE COUNTY RESOURCE MANAGEMENT.
- AT THE TIME OF PLATTING AN ACCESS EASEMENT SHALL BE GRANTED ACROSS LOT C2 TO PROVIDE ACCESS FROM TRACT B OF THE SURVEY RECORDED IN BOOK 410, PAGE 871 TO BURGHLEY DRIVE AND/OR CLEVEDON DRIVE. EXACT LOCATION OF EASEMENT TO BE DETERMINED BY THE DEVELOPER AND APPROVED BY THE CITY.
- PER 29-4.4(d)(4) - LOTS THAT CONTAIN DETACHED OR ATTACHED RESIDENCES AND WHICH HAVE SIDE OR REAR PROPERTY BOUNDARIES ABUTTING COLLECTOR OR ARTERIAL STREET RIGHT-OF-WAY SHALL HAVE SCREENING EITHER ALONG SUCH BOUNDARIES OR AROUND ANY PATIOS ON THE LOT WHICH ARE VISIBLE FROM THE RIGHT-OF-WAY.